

Product Catalog



Web : www.tayfuncooling.com

Mail : info@tayfuncooling.com

Gsm : +90 (536) 794 53 53

Technical Specifications / Teknik Özellikler



Low Emission
Düşük Geçirgenlik



Energy-Saving Fan
Enerji Tasarruflu Fan



Loading Capacity
Artırılmış Yükleme
Kapasitesi



Antifog Doors
Antifog Kapı

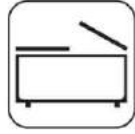

Covers Available
Opsiyonel Kapak



Visibility
Artırılmış Görünürlük



Small Footprint
Daha Az Alan İgall

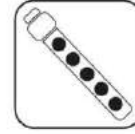

Bar Led



Tube Led



Doors Available
Opsiyonel Kapı



Micro Ventilation
Mikro Üfleme

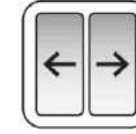

Sliding System
Opsiyonel Sürgülü
Kapak

Refrigerants / Soğutucu Gazlar



Serve Over Counters Glass Types / Şarküteri Cam Opsiyonları

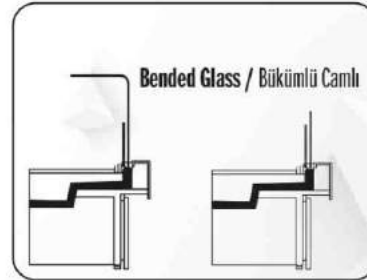
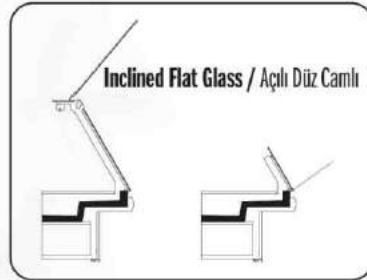
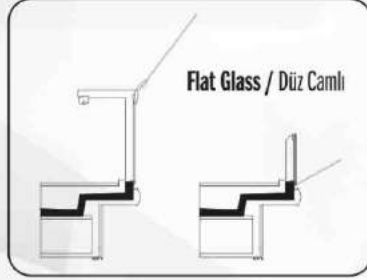
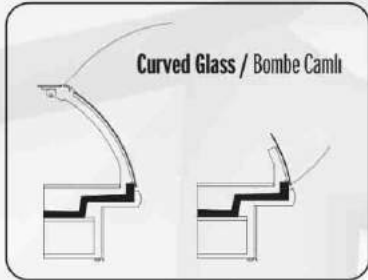

Door Options For Multidecks

Duvar Tipi Soğutucular İçin Kapı Opsiyonları



Hinged Single Glass Door
Menteşeli Tek Camlı Kapı



Hinged Double Glass Door
Menteşeli Çift Camlı Kapı



Sliding Double Glass Door
Kayar Çift Camlı Kapı



Sliding Glass Cover
Sürgülü Cam Kapak



Push Glass Cover
İleri İtme Cam Kapak

Top Glass Lid Options For Island Type Freezers

Ada Tipi Derin Dondurucular İçin Üst Cam Kapak Opsiyonları

All of our products are designed to be applicable for glass door and frame systems

Enerji Tassarufu Uygulamaları

Advantages of the Glass Door equipped cabinet

Cam Kapılı Reyonun Avantajları

- ✓ Energy consumption of the cabinet is highly reduced
- ✓ Product quality and shelf life is enhanced by more efficient control of the temperature
- ✓ Display area is optimized with reference to hygienic Conditions (closed area)
- ✓ Modern style of product display is provided

- ✓ Soğutma kabinin enerji tüketimi büyük oranda düşmektedir
- ✓ Daha etkin ısı kontrolü sayesinde ürün kalitesi ve raf ömrü artmaktadır
- ✓ Hijyen Koşulları açısından teşhir alanı optimal düzeydedir (kapalı alan)
- ✓ Modern görünümlü ürün teşhiri sağlanması

We propose high efficiency led lighting and electronic fans as option in all of our products.

Ürünlerimizin tümünde yüksek enerji verimli led aydınlatma ve elektronik fanlar opsiyonel olarak sunulmaktadır.

All of our products are adapted to use the Glass Door Opening Systems regarding design.

Ürünlerimizin tümü cam kapı ve çerçeve sistemleri uygulanabilir şekilde tasarlanmıştır.

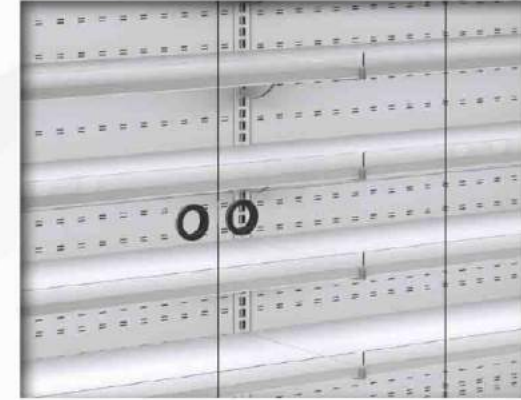

- ✓ Energy consumption of the refrigerated cabinets can be reduced by 70% with using Glass Door Systems.
- ✓ Cam kapı ve çerçeve sistemlerinin kullanımı soğutucu reyonlarda %70'e varan enerji tasarrufu sağlamaktadır.

Refrigerated Multideck Cabinet
Duvar Tipi Soğutucu Reyon



Operating Temperatures / Çalışma Sıcaklıkları			Ambient Conditions Ortam Koşulları
DP	MT	FV	
M2 (-1/+7°C)	M1 (-1/+5°C)	H1 (+1/+10°C)	25°C / 60% RH (EN ISO 23953-2)

Available Modules / Kullanılabilir Modüller					
Length/Uzunluk (mm)	1250	1875	2500	3750	Gondola / Head
Side panel/ Yan kapak (mm)	40	40	40	40	40

Technical Specifications / Teknik Özellikler



Categories / Kategoriler

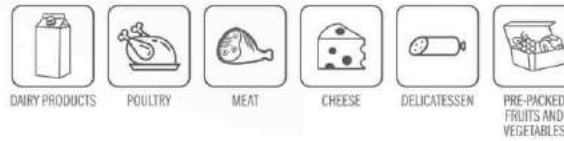

Dairy Products Sütlük

Packed Meat Paket Et

Fruits & Vegetables Sebze & Meyve

LION DP/110/220-205

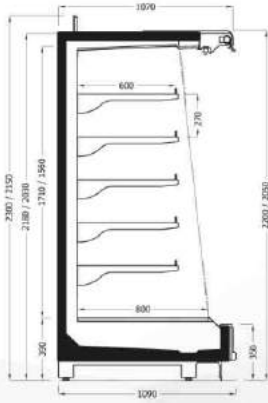

LION DP/100/220-205

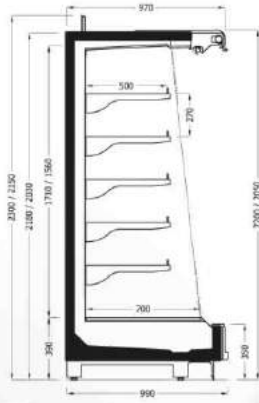

LION MT/110/220-205

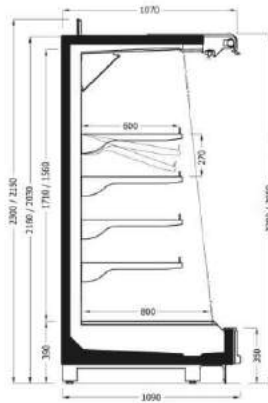

LION MT/100/220-205

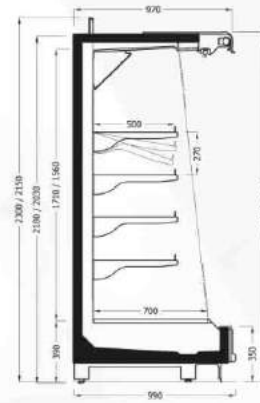

LION FV/110/220-205

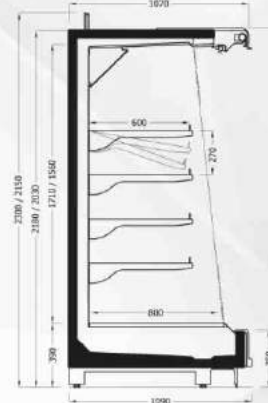

LION FV/100/220-205

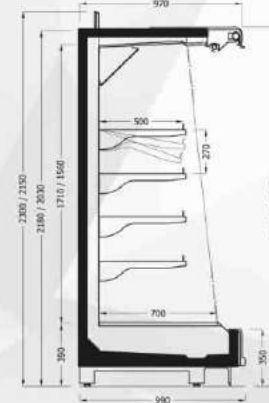

LION DP/90/220-205

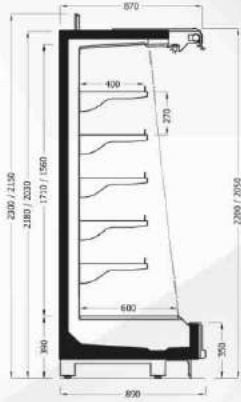

LION DP/75/220-205

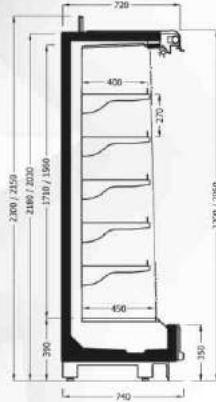

LION MT/90/220-205

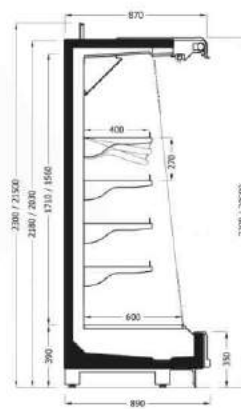

LION MT/75/220-205

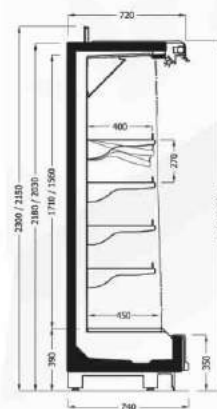

LION FV/90/220-205

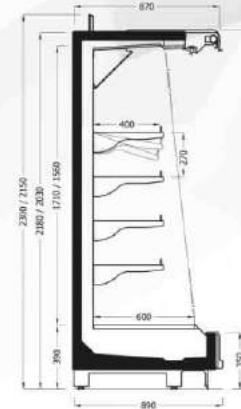

LION FV/75/220-205

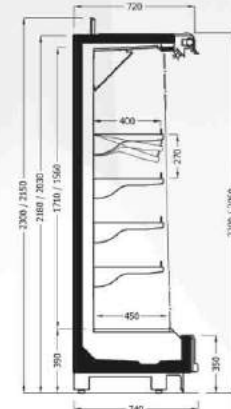

Refrigerated Multideck Cabinet
Double Glass Hinged Door

Duvar Tipi Soğutucu Reyon
Isıcamlı Çarpma Kapılı



Operating Temperatures / Çalışma Sıcaklıkları			Ambient Conditions Ortam Koşulları
DP	MT	FV	
M2 (-1/+7°C)	M1 (-1/+5°C)	H1 (+1/+10°C)	25°C / 60% RH (EN ISO 23953-2)

Available Modules / Kullanılabilir Modüller					
Length/Uzunluk (mm)	1250	1875	2500	3750	Gondola / Head
Side panel/ Yan kapak (mm)	40	40	40	40	40

Technical Specifications / Teknik Özellikler



Categories / Kategoriler



Dairy Products Sütlük

LION DP/110/220-205/DGD

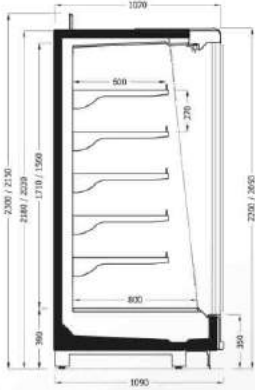

LION DP/100/220-205/DGD

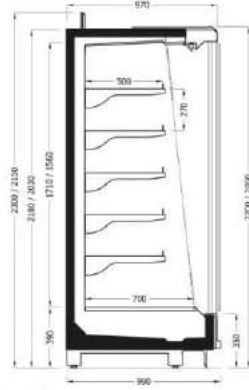

LION DP/90/220-205/DGD

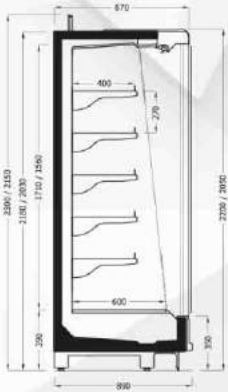

LION DP/75/220-205/DGD

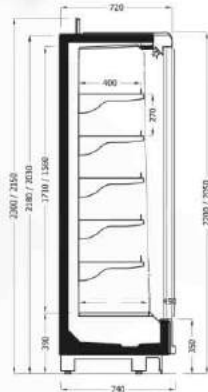

Packed Meat Paket Et

LION MT/110/220-205/DGD

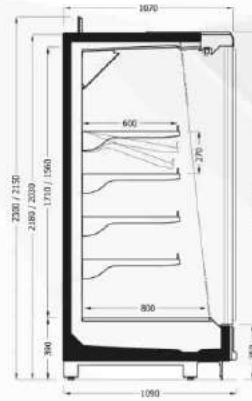

LION MT/100/220-205/DGD

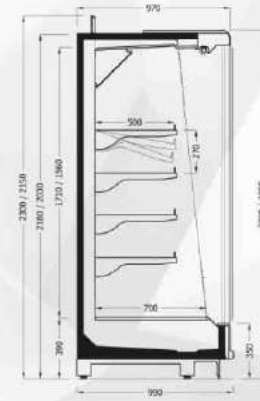

LION MT/90/220-205/DGD

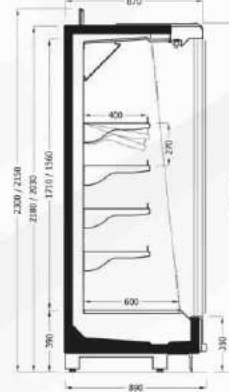

LION MT/75/220-205/DGD

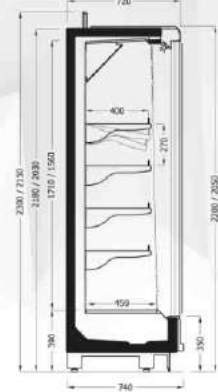

Refrigerated Multideck Cabinet
Double Glass Sliding Door

Duvar Tipi Soğutucu Reyon
Isıcamlı Sürgü Kapılı



Operating Temperatures / Çalışma Sıcaklıkları			Ambient Conditions Ortam Koşulları
DP	MT	FV	
M2 (-1/+7°C)	M1 (-1/+5°C)	H1 (+1/+10°C)	25°C / 60% RH (EN ISO 23953-2)

Available Modules / Kullanılabilir Modüller					
Length/Uzunluk (mm)	1250	1875	2500	3750	Gondola / Head
Side panel/ Yan kapak (mm)	40	40	40	40	40

Technical Specifications / Teknik Özellikler



Categories / Kategoriler



Dairy Products Sütlük

LION DP/110/220-205/SLD

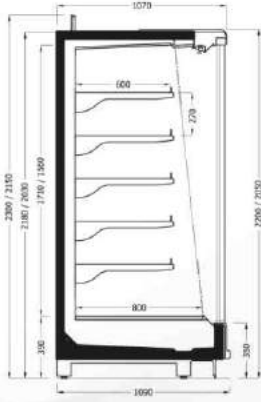

LION DP/100/220-205/SLD

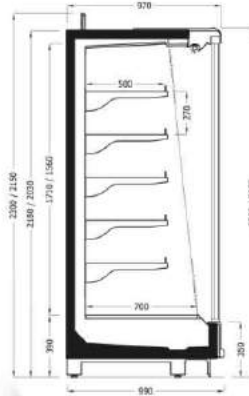

LION DP/90/220-205/SLD

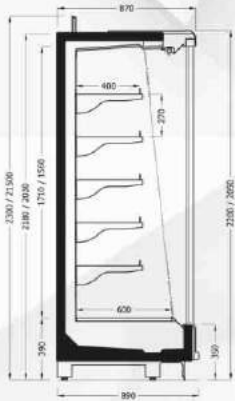

LION DP/75/220-205/SLD

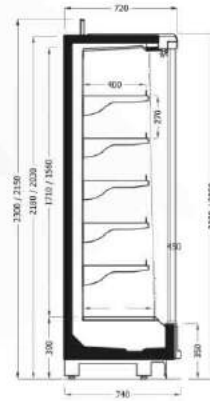

Packed Meat Paket Et

LION MT/110/220-205/SLD

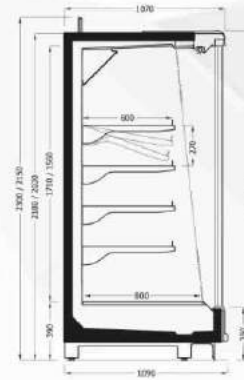

LION MT/100/220-205/SLD

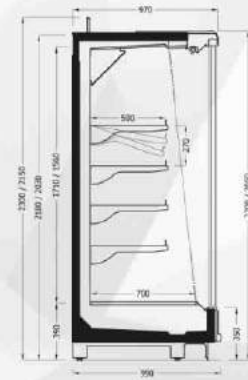

LION MT/90/220-205/SLD

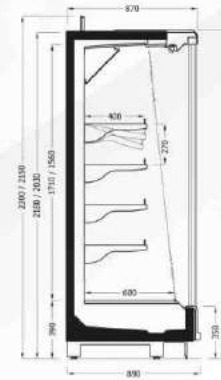

LION MT/75/220-205/SLD

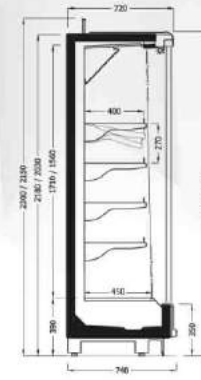

Refrigerated Multideck Cabinet
Single Glass Hinged Door

Duvar Tipi Soğutucu Reyon
Tek Camlı Çarpma Kapılı



Operating Temperatures / Çalışma Sıcaklıkları			Ambient Conditions Ortam Koşulları
DP	MT	FV	
M2 (-1/+7°C)	M1 (-1/+5°C)	H1 (+1/+10°C)	25°C / 60% RH (EN ISO 23953-2)

Available Modules / Kullanılabilir Modüller					
Length/Uzunluk (mm)	1250	1875	2500	3750	Gondola / Head
Side panel/ Yan kapak (mm)	40	40	40	40	40

Technical Specifications / Teknik Özellikler



Categories / Kategoriler



Dairy Products Sütlük

LION DP/110/220-205/SGD

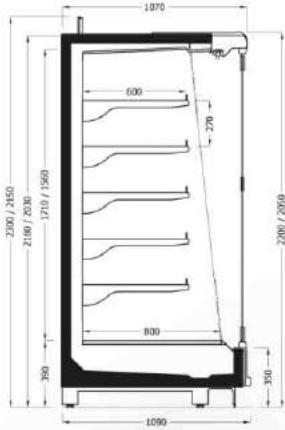

LION DP/100/220-205/SGD

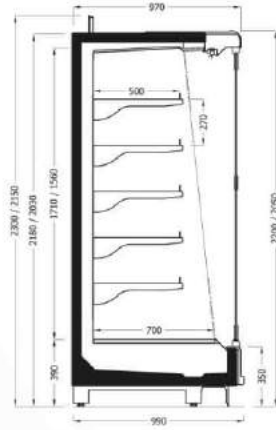

LION DP/90/220-205/SGD

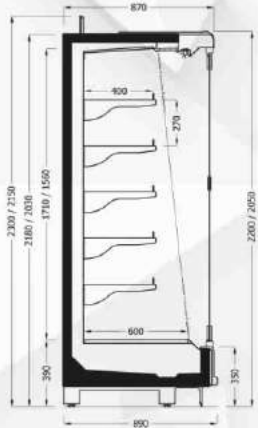

LION DP/75/220-205/SGD

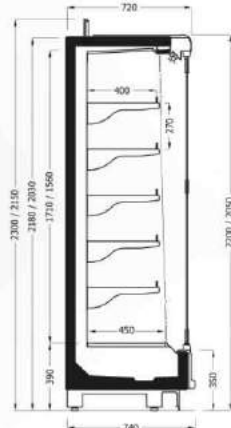

Packed Meat Paket Et

LION MT/110/220-205/SGD

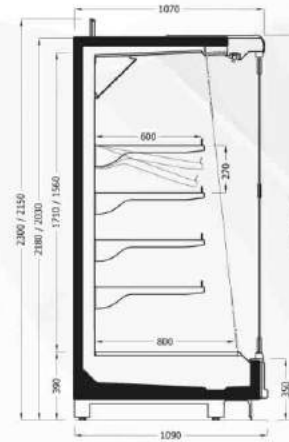

LION MT/100/220-205/SGD

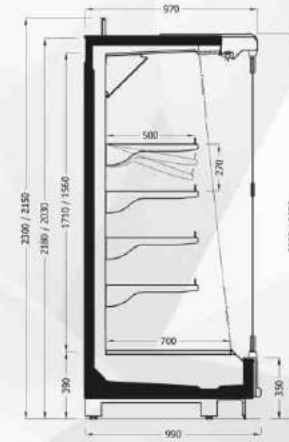

LION MT/90/220-205/SGD

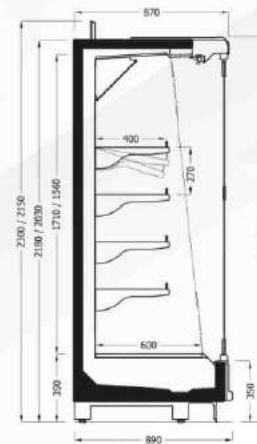

LION MT/75/220-205/SGD

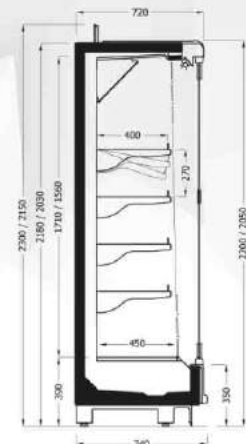

Refrigerated Multideck Cabinet
Double Glass Hinged Door W/O Frame

Duvar Tipi Soğutucu Reyon
Çerçevesiz Isıcamlı Çarpma Kapılı



Operating Temperatures / Çalışma Sıcaklıkları			Ambient Conditions Ortam Koşulları
DP	MT	FV	
M2 (-1/+7°C)	M1 (-1/+5°C)	H1 (+1/+10°C)	25°C / 60% RH (EN ISO 23953-2)

Available Modules / Kullanılabilir Modüller					
Length/Uzunluk (mm)	1250	1875	2500	3750	Gondola / Head
Side panel/ Yan kapak (mm)	40	40	40	40	40

Technical Specifications / Teknik Özellikler



Categories / Kategoriler



Dairy Products Sütlük

LION DP SKY/110/220-205

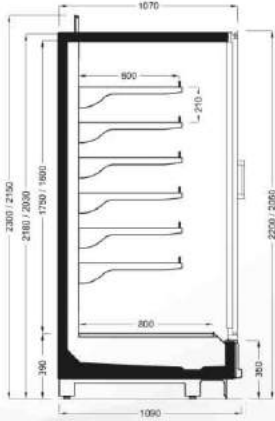

LION DP SKY/100/220-205

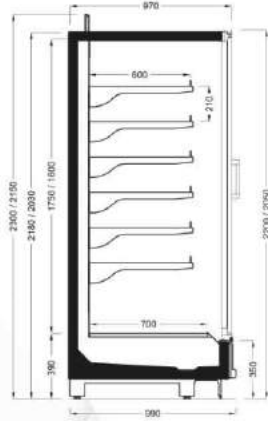

LION DP SKY/90/220-205

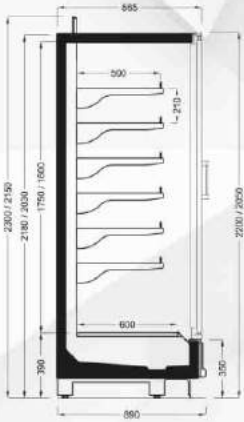

LION DP SKY/75/220-205

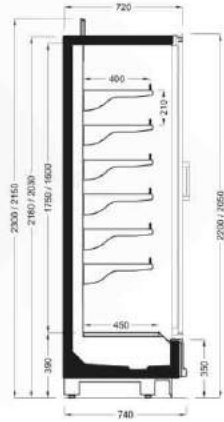

Packed Meat Paket Et

LION MT SKY/110/220-205

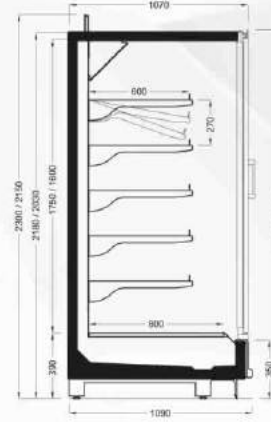

LION MT SKY/100/220-205

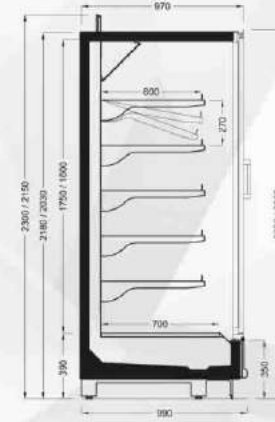

LION MT SKY/90/220-205

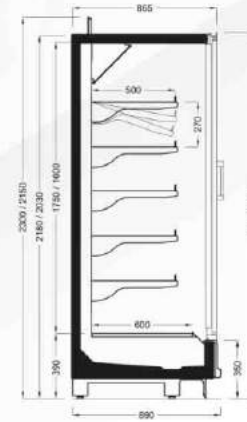

LION MT SKY/75/220-205

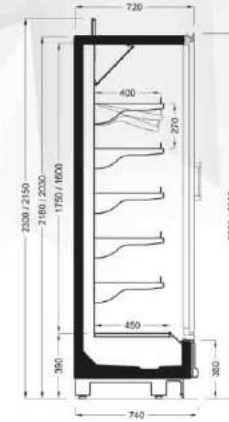

FIRTINA CC

Refrigerated Multideck Cabinet For Column Cover
Duvar Tipi Soğutucu Kolon Kaplama Reyonu



LION CC 75/90-100-110/220-205

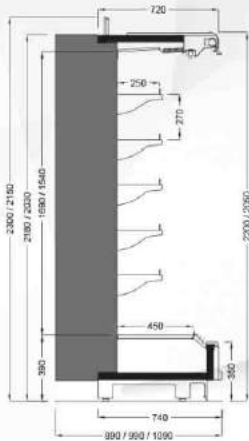

LION CC/750 L1250

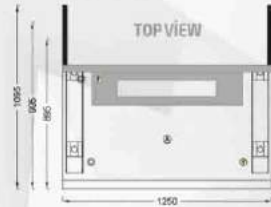

⚡ ELECTRICAL CONNECTION ○ COPPER TUBE 🚰 DRAINAGE

LION CC/750 L937

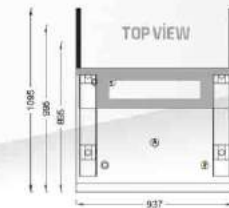

⚡ ELECTRICAL CONNECTION ○ COPPER TUBE 🚰 DRAINAGE

FIRTINA RETROBANCO



Multi-decks
Sütlekler

Refrigerated Semivertical Cabinet with Storage
Duvar Tipi Depolu Yarı Dikey Soğutucu Reyon

LION DP/75/1500 (RT B)

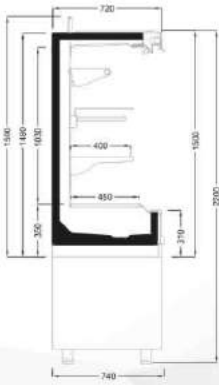

LION DP/75/1500 (RT)

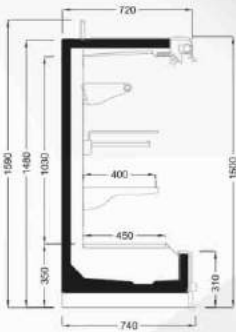

Operating Temperatures / Çalışma Sıcaklıkları		Ambient Conditions Ortam Koşulları
DP	MT	
M2 (-1/+7°C)	M1 (-1/+5°C)	25°C / 60% RH (EN ISO 23953-2)

Available Modules / Kullanılabilir Modüller				
Length/Uzunluk (mm)	1250	1875	2500	3750
Side panel/ Yan kapak (mm)	40	40	40	40

Categories / Kategoriler



DAIRY PRODUCTS CHEESE DELICATESSEN



TAYFUN COOLING
Sogutma Sanayi Tic.Ltd.Sti

Technical Specifications / Teknik Özellikler



Wall Type Refrigeration Fruit and Vegetables Cabinet
Soğutmalı Duvar Tipi Meyve Sebze Reyonu



LION FV-A/100/220-205

Operating Temperatures / Çalışma Sıcaklıkları	Ambient Conditions Ortam Koşulları
FV	
H1 (+1/+10°C)	25°C / 60% RH (EN ISO 23953-2)

Available Modules / Kullanılabilir Modüller					
Length/Uzunluk (mm)	1250	1875	2500	3750	Gondola / Head
Side panel/ Yan kapak (mm)	40	40	40	40	40

Technical Specifications / Teknik Özellikler

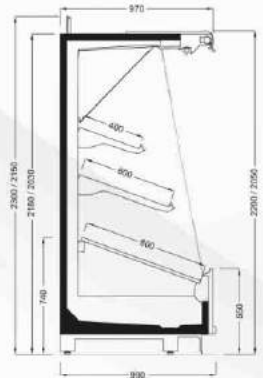

Vertical - Semi Vertical Refrigerated Fruit & Vegetables Cabinet
Dikey - Yarıdikey Soğutmalı Meyve & Sebze Reyonu



RHINO 125/H220

RHINO 125/H160

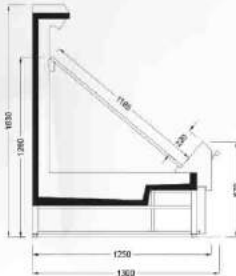
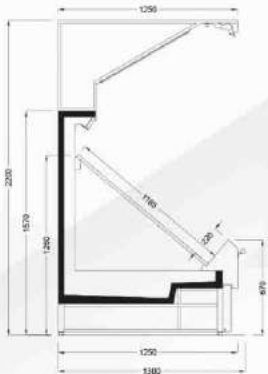

Technical Specifications / Teknik Özellikler



Categories
Kategoriler



FRUIT AND
VEGETABLES



PRE-PACKED
FRUITS AND
VEGETABLES



Operating Temperatures / Çalışma Sıcaklıkları	Ambient Conditions Ortam Koşulları
FV	25°C / 60% RH (EN ISO 23953-2)
H1 (+1/+10°C)	

Available Modules / Kullanılabilir Modüller					
Length/Uzunluk (mm)	1250	1875	2500	3750	Gondola / Head
Side panel/ Yan kapak (mm)	40	40	40	40	40

Semivertical Refrigerated Cabinet
Yarı Dikey Soğutucu Reyon



Operating Temperatures / Çalışma Sıcaklıkları			Ambient Conditions Ortam Koşulları
DP	MT	FV	
M2 (-1/+7°C)	M1 (-1/+5°C)	H1 (+1/+10°C)	25°C / 60% RH (EN ISO 23953-2)

Available Modules / Kullanılabilir Modüller					
Length/Uzunluk (mm)	1250	1875	2500	3750	Gondola / Head
Side panel/ Yan kapak (mm)	40	40	40	40	40



Technical Specifications / Teknik Özellikler



Categories / Kategoriler

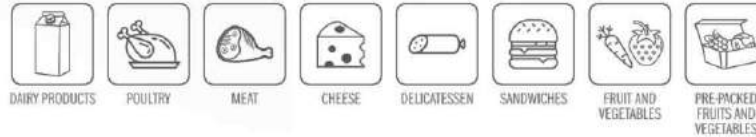

Dairy Products Sütlük

Packed Meat Paket Et

Fruits & Vegetables Sebze & Meyve

FALCON DP/110/180-170-160-150

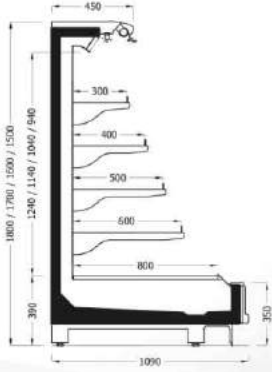

FALCON DP/100/180-170-160-150

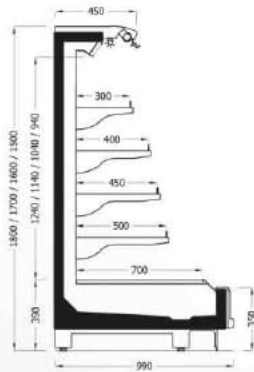

FALCON MT/110/180-170-160-150

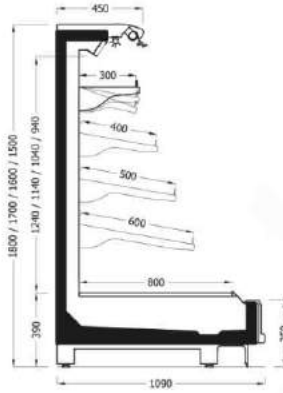

FALCON MT/100/180-170-160-150

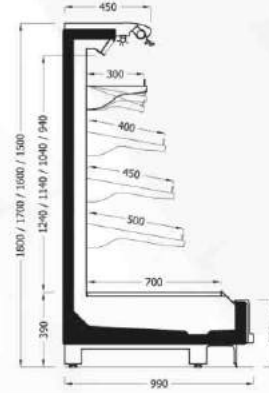

FALCON FV110/180-170-160-150

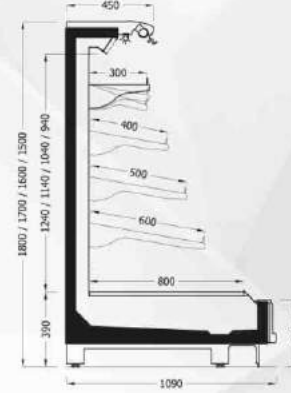

FALCON FV/100/180-170-160-150

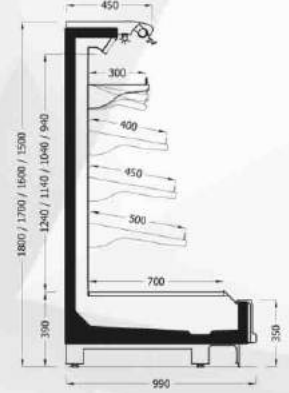

FALCON DP/90/180-170-160-150

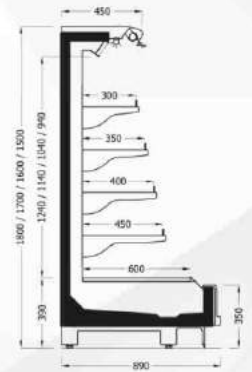

FALCON DP/75/180-170-160-150

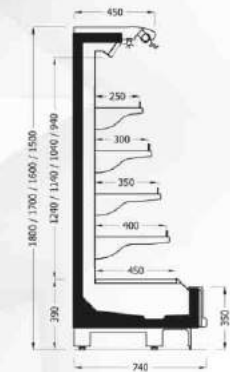

FALCON MT/90/180-170-160-150

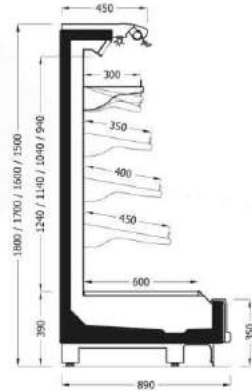

FALCON MT/75/180-170-160-150

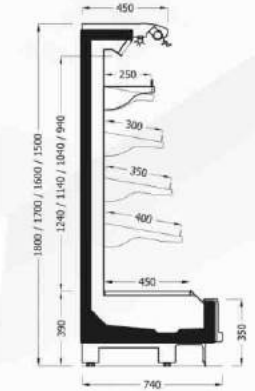

FALCON FV/90/180-170-160-150

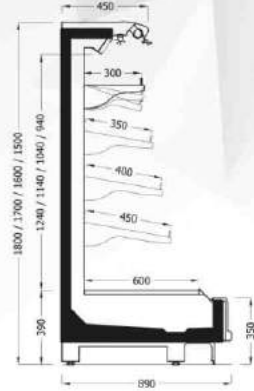

FALCON FV/75/180-170-160-150

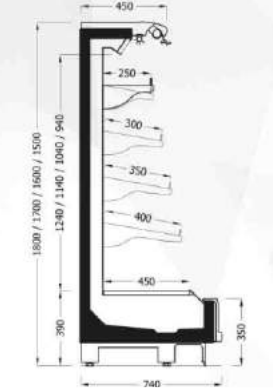

Semivertical Refrigerated Cabinet Single Glass Sliding Door

Yarı Dikey Soğutucu Reyon Tek Camlı Sürgü Kapılı

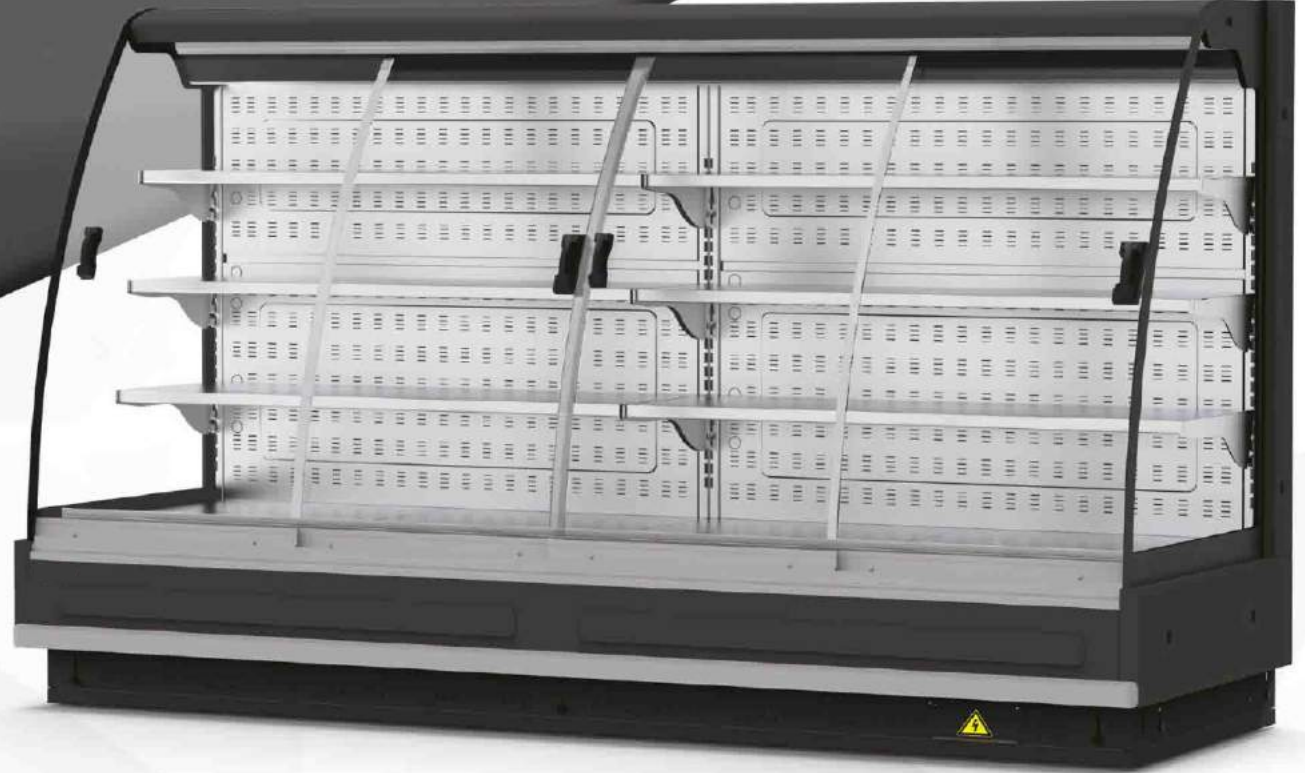

Operating Temperatures / Çalışma Sıcaklıkları		Ambient Conditions Ortam Koşulları
DP	MT	
M2 (-1/+7°C)	M1 (-1/+5°C)	25°C / 60% RH (EN ISO 23953-2)

Available Modules / Kullanılabilir Modüller					
Length/Uzunluk (mm)	1250	1875	2500	3750	Gondola / Head
Side panel/ Yan kapak (mm)	40	40	40	40	40

Technical Specifications / Teknik Özellikler

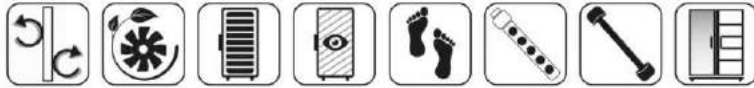

Categories / Kategoriler



Dairy Products Sütlük

FALCON DP/110/180-170-160-150 SLD

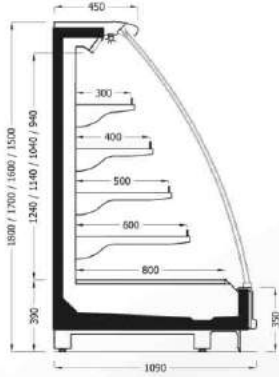

FALCON DP/100/180-170-160-150 SLD

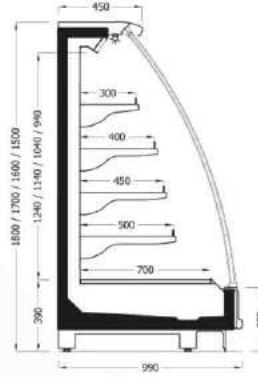

FALCON DP/90/180-170-160-150 SLD

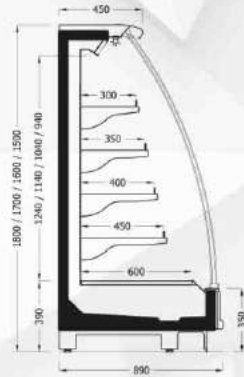

FALCON DP/75/180-170-160-150 SLD

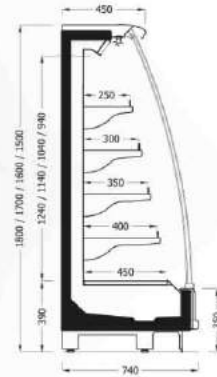

Packed Meat Paket Et

FALCON MT/110/180-170-160-150 SLD SG

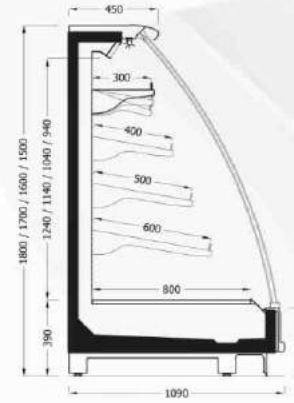

FALCON MT/100/180-170-160-150 SLD SG

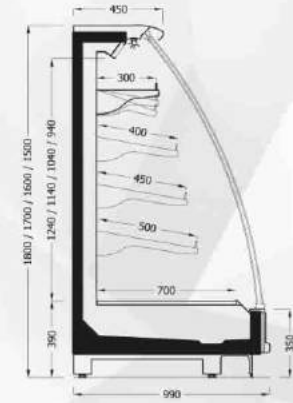

FALCON MT/90/180-170-160-150 SLD SG

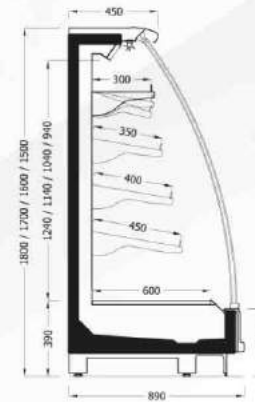

FALCON MT/75/180-170-160-150 SLD SG

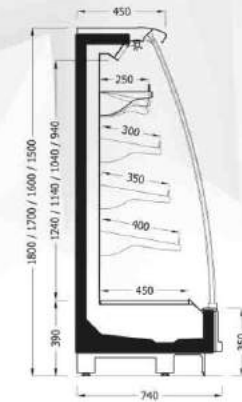

Glass Door Bottle Cooler

Cam Kapılı Şişe Soğutucu



Available Modules / Kullanılabilir Modüller				
Length (mm) Uzunluk (mm)	2D	3D	4D	5D
	1562	2343	3124	3905
Side panel (mm) Yan kapak (mm)	40	40	40	40

Operating Temperatures Çalışma Sıcaklıkları	Ambient Conditions Ortam Koşulları
H1 (+1/+10°C)	25°C / 60% RH (EN ISO 23953-2)

Technical Specifications / Teknik Özellikler



Categories / Kategoriler



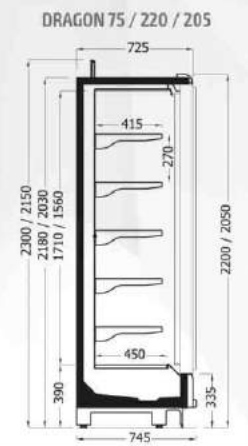
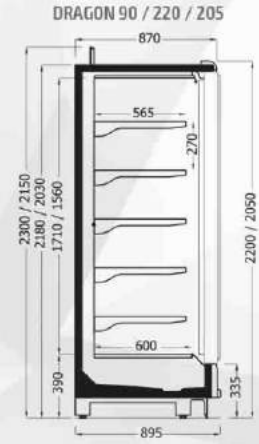

Upright Cooler
Şişe Soğutucu



Refrigerated Serve Over Counter With Curved Glass

Bombe Camlı Soğutmalı Servis Reyonu



Available Modules / Kullanılabilir Modüller						
Length (mm) Uzunluk (mm)	937	1250	1875	2500	3750	Corner Modules Köşe Modülleri
Side panel (mm) Yan kapak (mm)	40	40	40	40	40	40

Operating Temperatures Çalışma Sıcaklıkları	Ambient Conditions Ortam Koşulları
M1 (-1/+5°C) - M2 (-1/+7°C)	25°C / 60% RH (EN ISO 23953-2)

Technical Specifications / Teknik Özellikler



Categories / Kategoriler

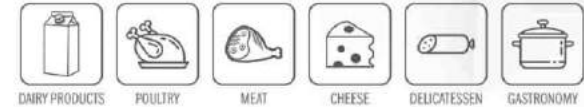

DAIRY PRODUCTS POULTRY MEAT CHEESE DELICATESSEN GASTRONOMY



TAYFUN COOLING
Sogutma Sanayi Tic.Ltd.Sri

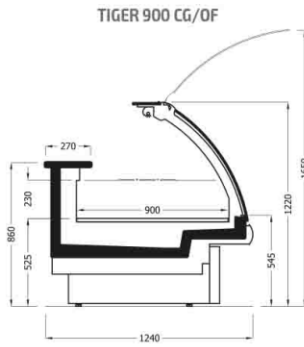
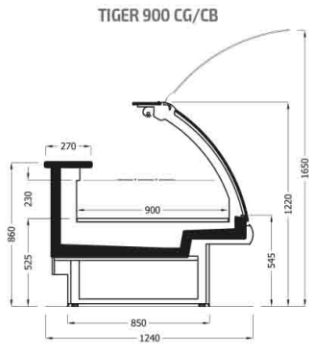

TIGER 900 CG/CB-OF/IC 45°



TIGER 900 CG/CB-OF/IC 90°

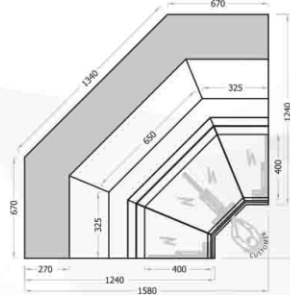

TIGER 900 CG/CB-OF/OC 45°



TIGER 900 CG/CB-OF/OC 90°

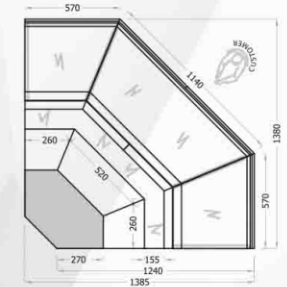

TIGER 800 CG/CB

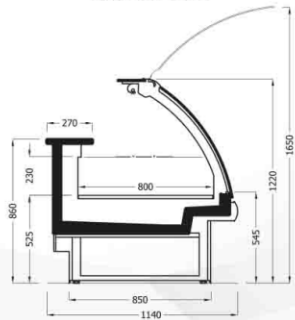

TIGER 800 CG/OF

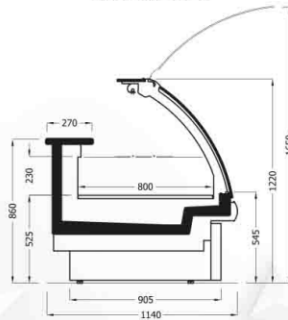

TIGER 900 CG/CB-OF/ICC 45°

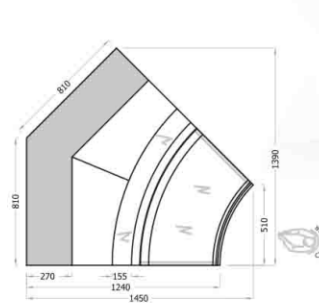

TIGER 900 CG/CB-OF/ICC 90°

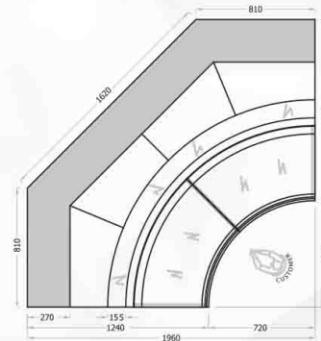

TIGER 900 CG/CB-OF/OCC 45°

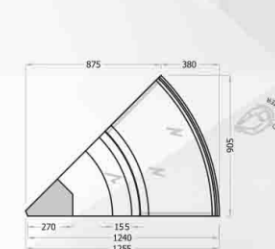

TIGER 900 CG/CB-OF/OCC 90°

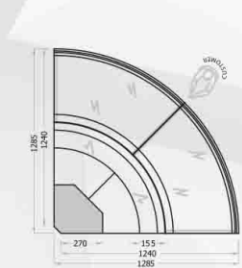

TIGER 900 CG/SS/CB

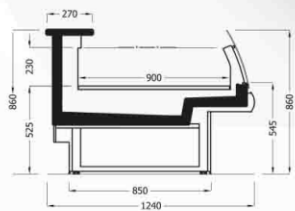

TIGER 900 CG/SS/OF

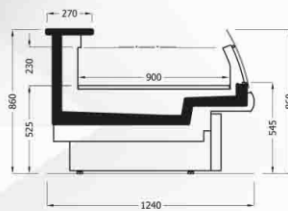

TIGER 800 CG/CB-OF/IC 45°



TIGER 800 CG/CB-OF/IC 90°

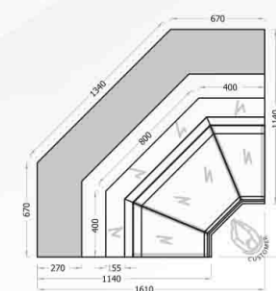

TIGER 800 CG/CB-OF/OC 45°



TIGER 800 CG/CB-OF/OC 90°

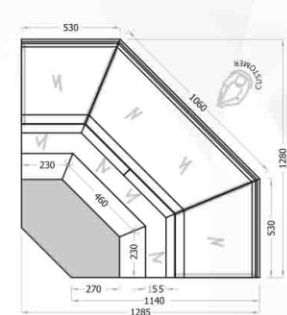

TIGER 800 CG/SS/CB

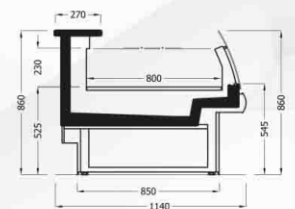

TIGER 800 CG/SS/OF

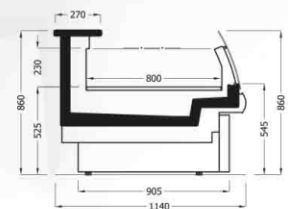

Serve-Over Counters
Servis Reyonları

Refrigerated Serve Over Counter With Flat Glass

Düz Camlı Soğutmalı Servis Reyonu

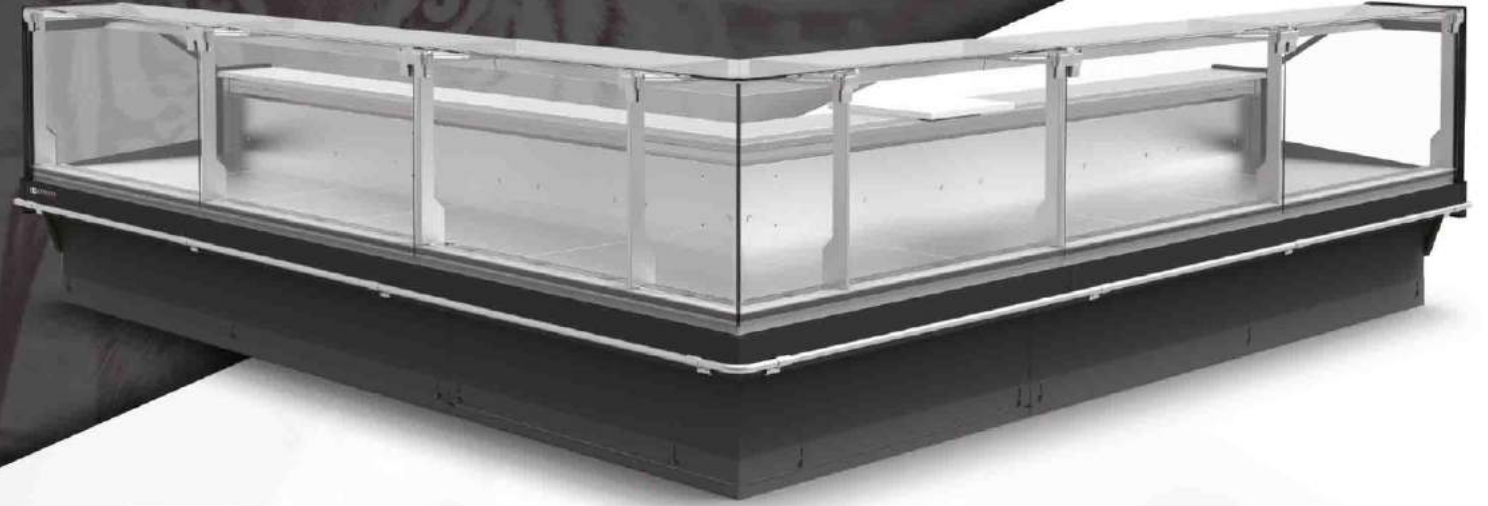

Available Modules / Kullanılabilir Modüller						
Length (mm) Uzunluk (mm)	937	1250	1875	2500	3750	Corner Modules Köşe Modülleri
Side panel (mm) Yan kapak (mm)	40	40	40	40	40	40

Operating Temperatures Çalışma Sıcaklıkları	Ambient Conditions Ortam Koşulları
M1 (-1/+5°C) - M2 (-1/+7°C)	25°C / 60% RH (EN ISO 23953-2)

Technical Specifications / Teknik Özellikler



Categories / Kategoriler

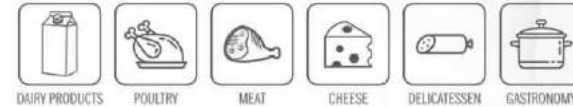

DAIRY PRODUCTS POULTRY MEAT CHEESE DELICATESSEN GASTRONOMY



TAYFUN COOLING
Soğutma Sanayi Tic.Ltd.Şti

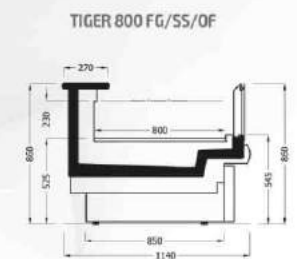
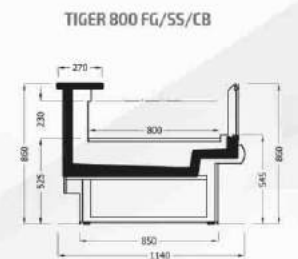
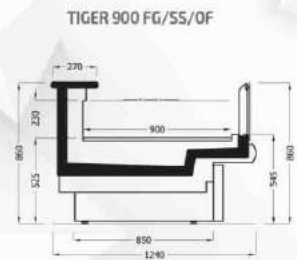
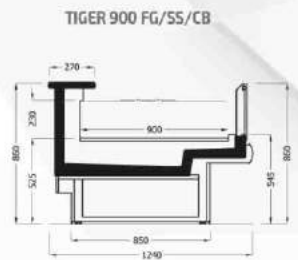
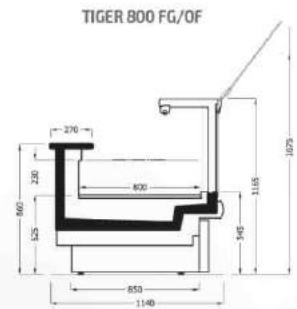
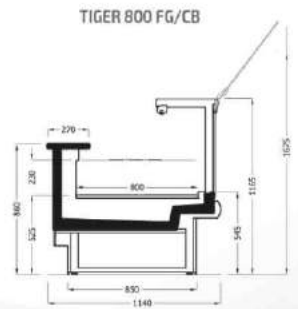
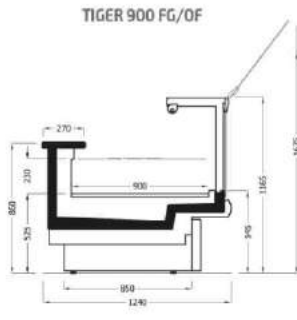
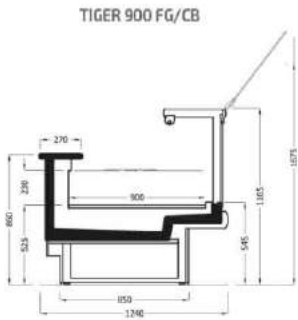

OPTIONAL MICRO VENTILATION

TIGER 900 FG/CB-OF/OC 90°

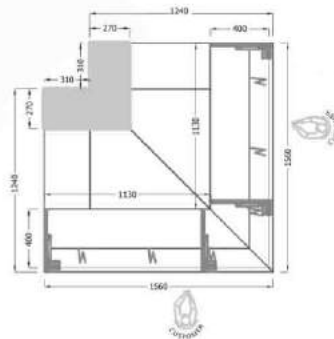

TIGER 800 FG/CB-OF/OC 90°

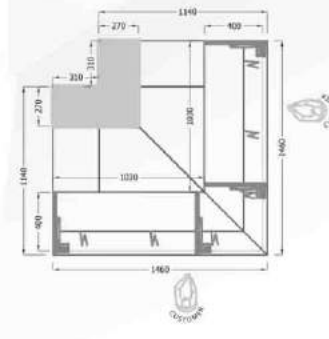

TIGER 900 FG/CB-OF/IC 90°

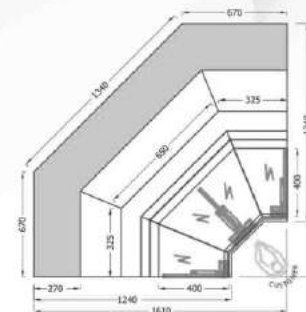

TIGER 800 FG/CB-OF/IC 90°

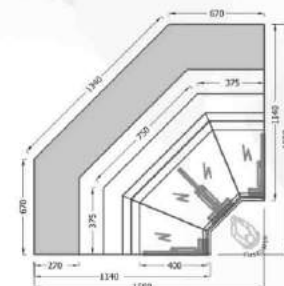

Serve-Over Counters
Servis Revyonları

Refrigerated Serve Over Counter With Angled Flat Glass

Açılı Düz Camlı Soğutmalı Servis Reyonu



Available Modules / Kullanılabilir Modüller						
Length (mm) Uzunluk (mm)	937	1250	1875	2500	3750	Corner Modules Köşe Modülleri
Side panel (mm) Yan kapak (mm)	40	40	40	40	40	40

Operating Temperatures Çalışma Sıcaklıkları	Ambient Conditions Ortam Koşulları
M1 (-1/+5°C) - M2 (-1/+7°C)	25°C / 60% RH (EN ISO 23953-2)

Technical Specifications / Teknik Özellikler



Categories / Kategoriler

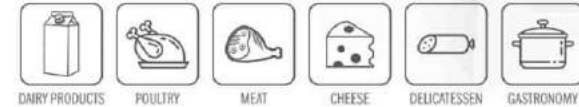

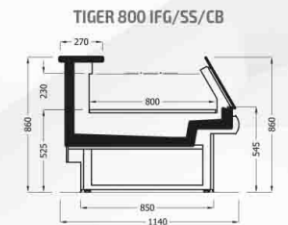
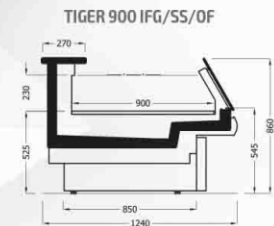
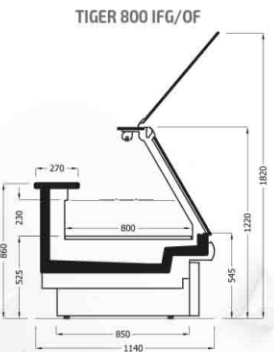
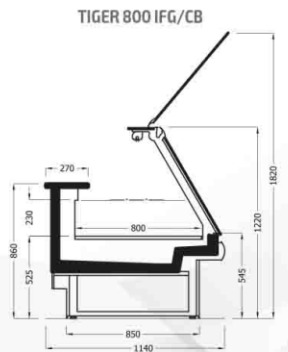
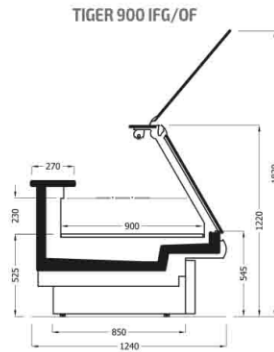
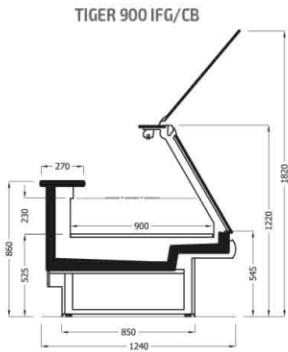

TIGER 900 IFG/CB-OF/IC 45°

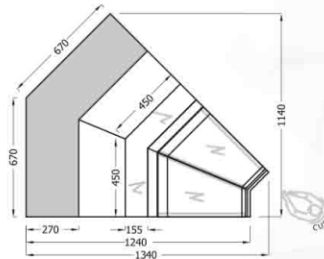

TIGER 900 IFG/CB-OF/IC 90°

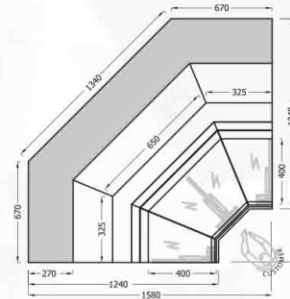

TIGER 900 IFG/CB-OF/OC 45°



TIGER 900 IFG/CB-OF/OC 90°

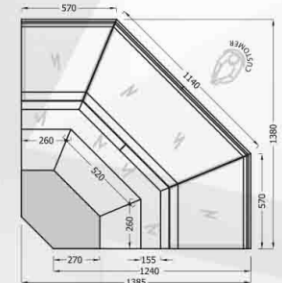

TIGER 800 IFG/CB-OF/IC 45°



TIGER 800 IFG/CB-OF/IC 90°

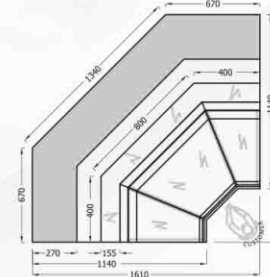

TIGER 800 IFG/CB-OF/OC 45°



TIGER 800 IFG/CB-OF/OC 90°

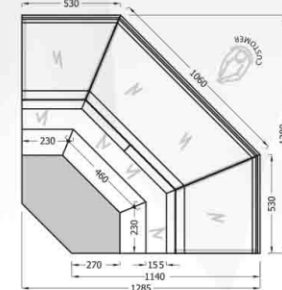

TAYFUN COOLING
Sogutma Sanayi Tic.Ltd.Sti

Serve-Over Counters
Servis Reyonları

Refrigerated Serve Over Counter With Both Ventilation and Static Cooling

Ventilasyonlu ve Statik Rejimli Soğutmalı Servis Reyonu

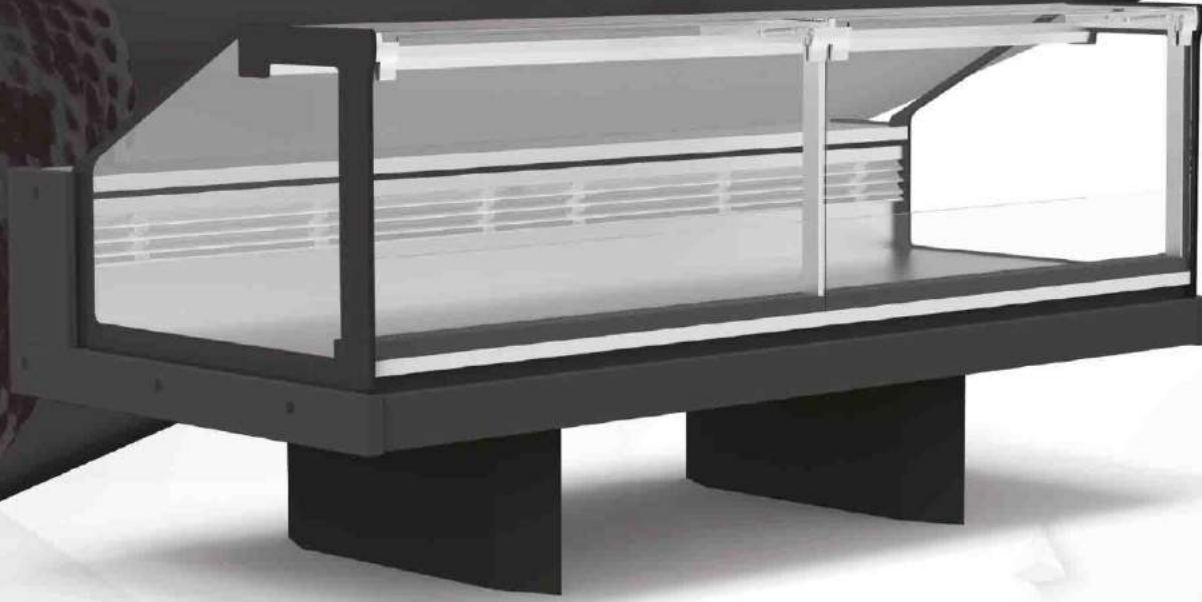

Available Modules / Kullanılabilir Modüller						
Length (mm) Uzunluk (mm)	937	1250	1875	2500	3750	Corner Modules Köşe Modülleri
Side panel (mm) Yan kapak (mm)	40	40	40	40	40	40

Operating Temperatures Çalışma Sıcaklıkları	Ambient Conditions Ortam Koşulları
M1 (-1/+5°C) - M2 (-1/+7°C)	25°C / 60% RH (EN ISO 23953-2)

Technical Specifications / Teknik Özellikler



COBRA 900 FG/CB

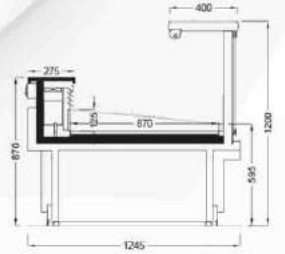

COBRA 900 FG/OF

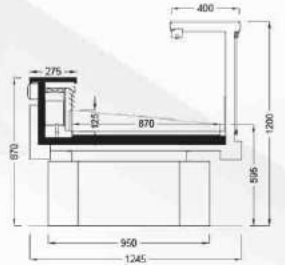

Categories / Kategoriler

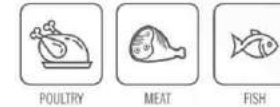

RÜZGAR TOWER

Refrigerated Carcass Meat Display Cabinet
Soğutmalı Karkas Et Teşhir Reyonu

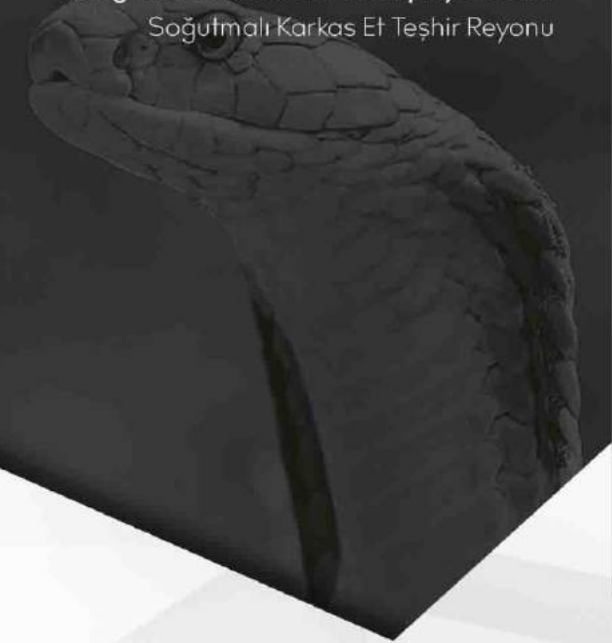
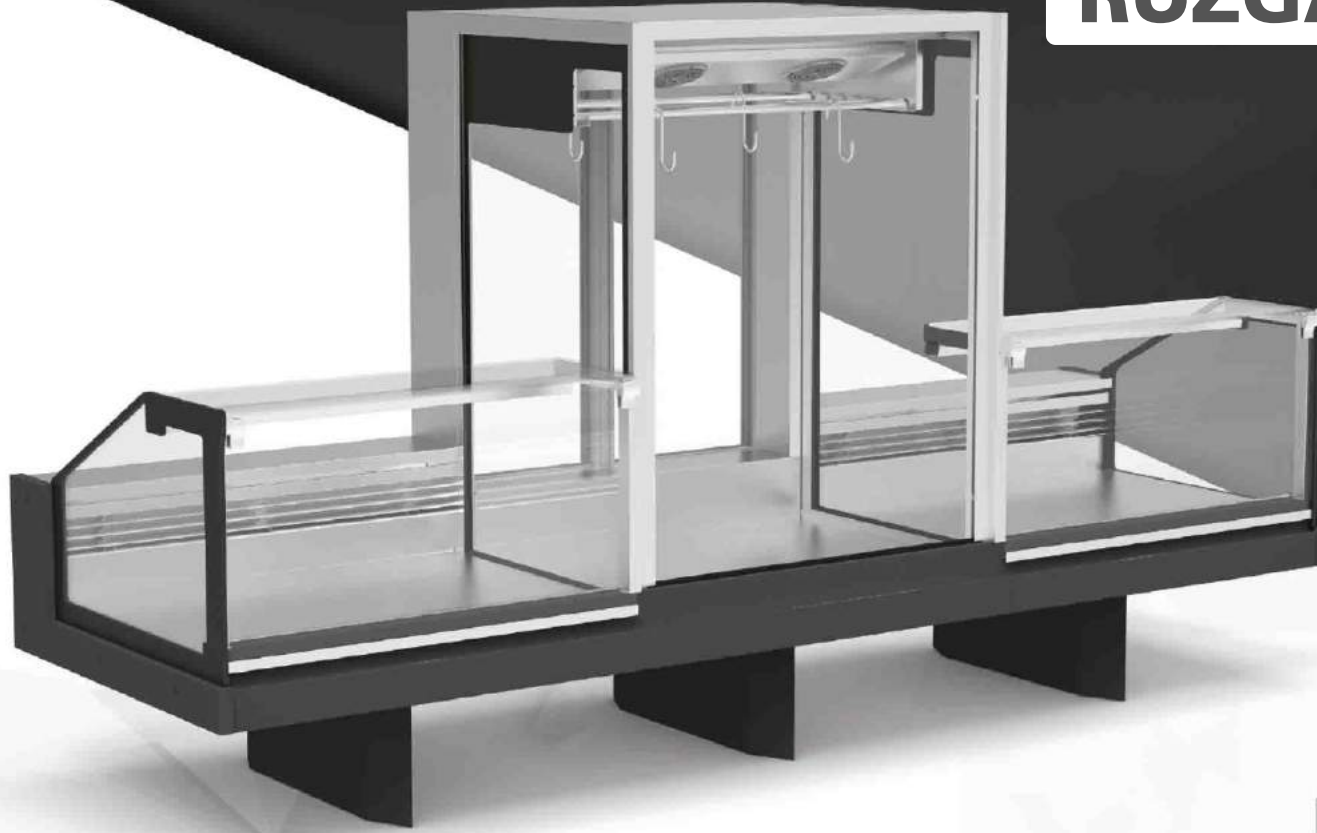

Service-Over Counters
Servis Reyonları

COBRA TOWER FG/OF

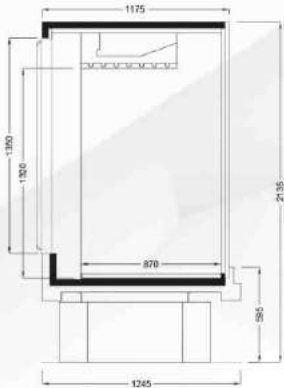

COBRA TOWER FG/CB

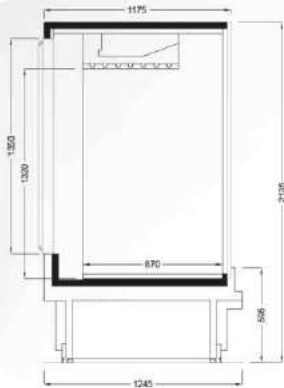

Available Modules / Kullanılabilir Modüller

Length (mm) Uzunluk (mm)	937	1250
Side panel (mm) Yan kapak (mm)	40	40

Operating Temperatures Çalışma Sıcaklıkları

M1 (-1/+5°C) - M2 (-1/+7°C)

Ambient Conditions Ortam Koşulları

25°C / 60% RH (EN ISO 23953-2)

Technical Specifications / Teknik Özellikler

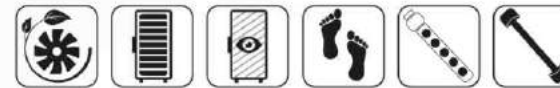

Categories Kategoriler

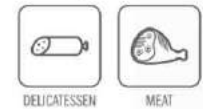

DELICATESSEN

MEAT



TAYFUN COOLING
Soğutma Sanayi Tic.Ltd.Şti

Refrigerated, Combined Serve Over Counter With Flat Glas
Düz Camlı, Soğutmalı Kombine Servis Reyonu



Available Modules / Kullanılabilir Modüller						
Length (mm) Uzunluk (mm)	937	1250	1875	2500	3750	Corner Modules Köşe Modüller
Side panel (mm) Yan kapak (mm)	40	40	40	40	40	40

Operating Temperatures Çalışma Sıcaklıkları	Ambient Conditions Ortam Koşulları
M1 (-1/+5°C) - M2 (-1/+7°C)	25°C / 60% RH (EN ISO 23953-2)

Technical Specifications / Teknik Özellikler



Categories / Kategoriler



QUOKKA COMBI 1600 FG

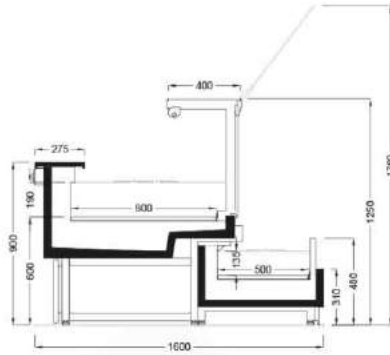

QUOKKA COMBI 1600 FG/SS

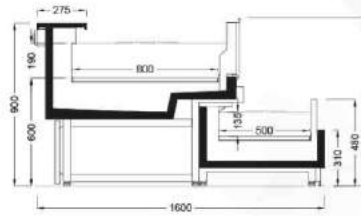

QUOKKA COMBI 1600 FG IC 90°

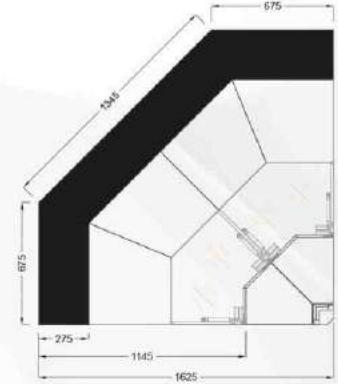

QUOKKA 800 FG

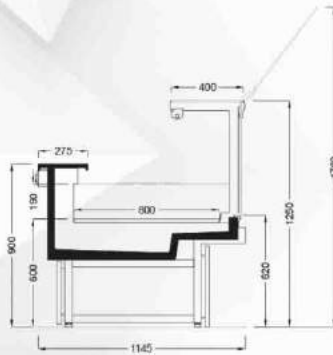

QUOKKA 800 FG/SS

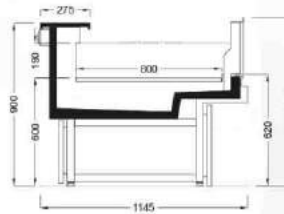

QUOKKA 800 FG IC 90°



Refrigerated Serve Over Counter With 90° Bended Glass

90° Bükümlü Camlı Soğutmalı Servis Reyonu

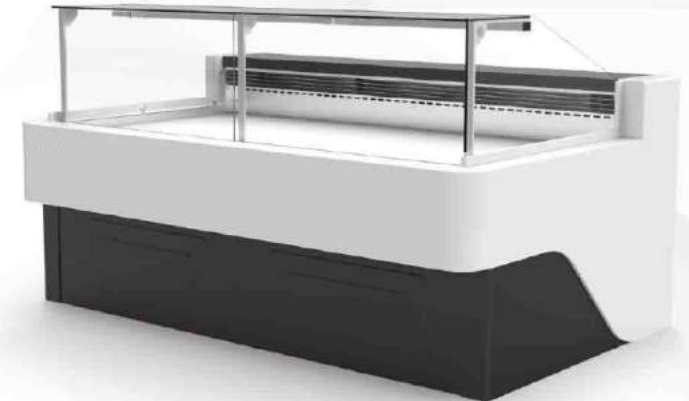
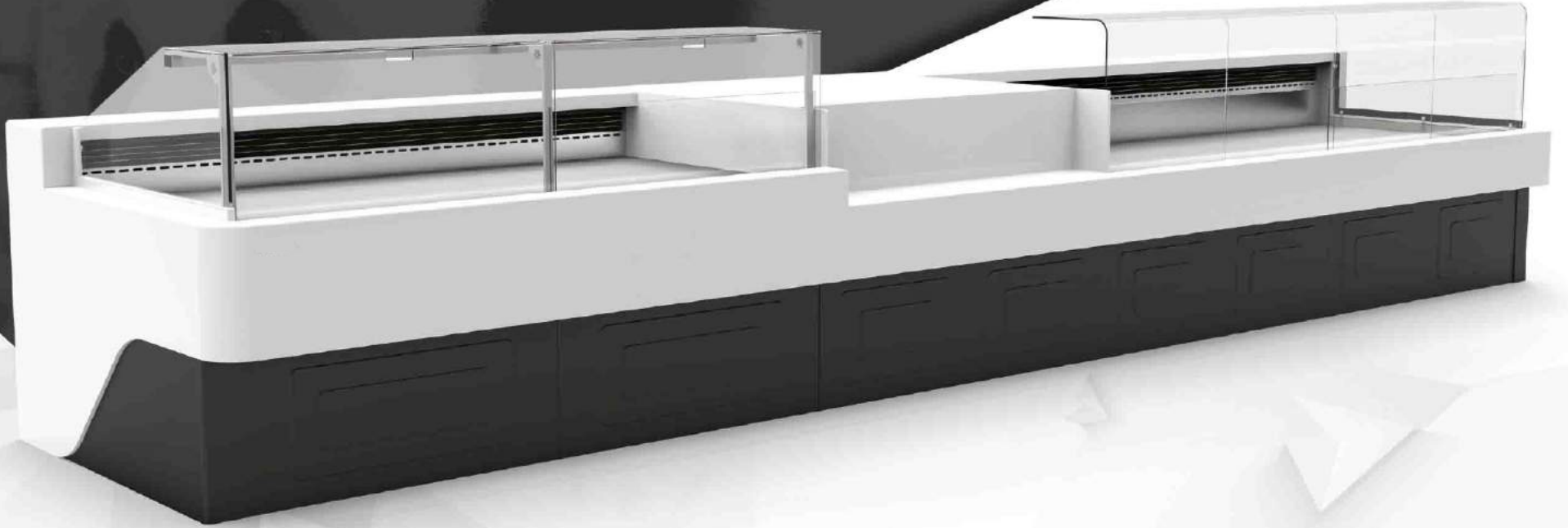

FRIO BFG



Refrigerated Serve Over Counter With 90° Bended Glass
90° Bükümlü Camlı Soğutmalı Servis Reyonu



Serve-Over Counters
Servis Reyonları



TAYFUN COOLING
Sogutma Sanayi Tic.Ltd.Sti

Refrigerated Serve Over Counter With 90° Bended Glass

90° Bükümlü Camlı Soğutmalı Servis Reyonu



Available Modules / Kullanılabilir Modüller						
Length (mm) Uzunluk (mm)	937	1250	1875	2500	3750	Corner Modules Köşe Modüller
Side panel (mm) Yan kapak (mm)	40	40	40	40	40	40

Operating Temperatures Çalışma Sıcaklıkları	Ambient Conditions Ortam Koşulları
M1 (-1/+5°C) - M2 (-1/+7°C)	25°C / 60% RH (EN ISO 23953-2)

Technical Specifications / Teknik Özellikler

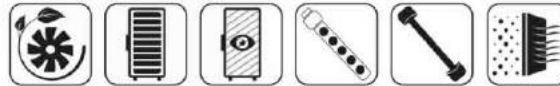

Categories / Kategoriler



CHEETAH 900 BFG/CB

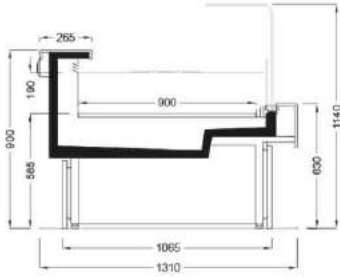

CHEETAH 800 BFG/CB

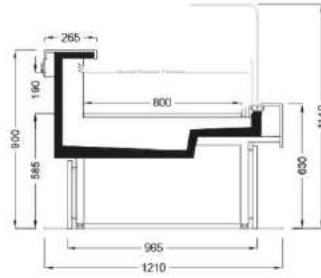

CHEETAH 700 BFG/CB

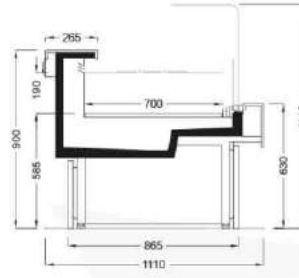

CHEETAH 900 BA

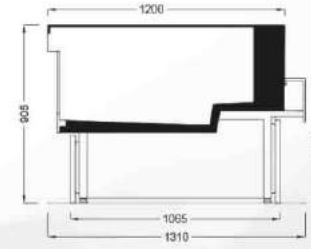

CHEETAH 900 MV BFG/CB

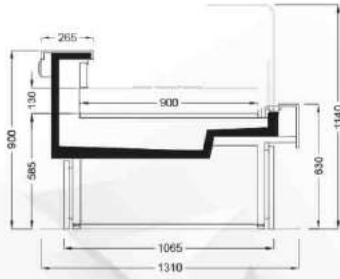

CHEETAH 800 MV BFG/CB

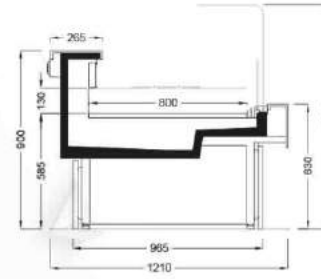

CHEETAH 700 MV BFG/CB

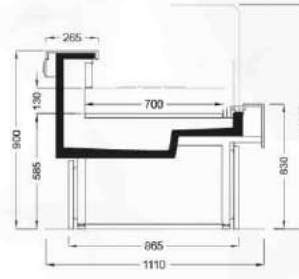

CHEETAH 800 BA

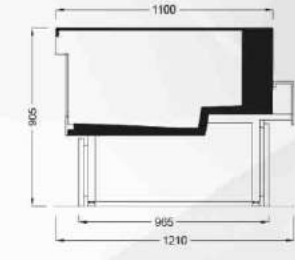

CHEETAH 900 BFG/CB OC90°

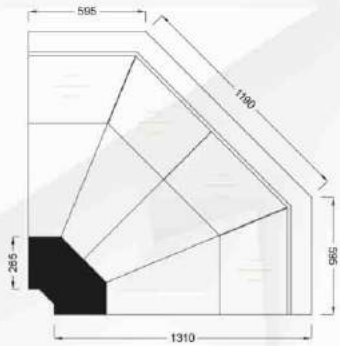

CHEETAH 800 BFG/CB OC90°

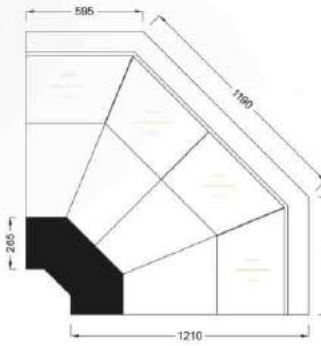

CHEETAH 700 BFG/CB OC90°



CHEETAH 700 BA

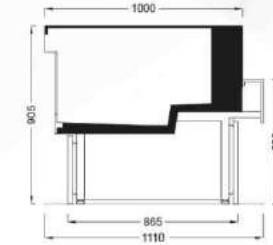

Chocolate and Pastry Serve-Over Counter
Çikolata ve Pasta Servis Reyonu

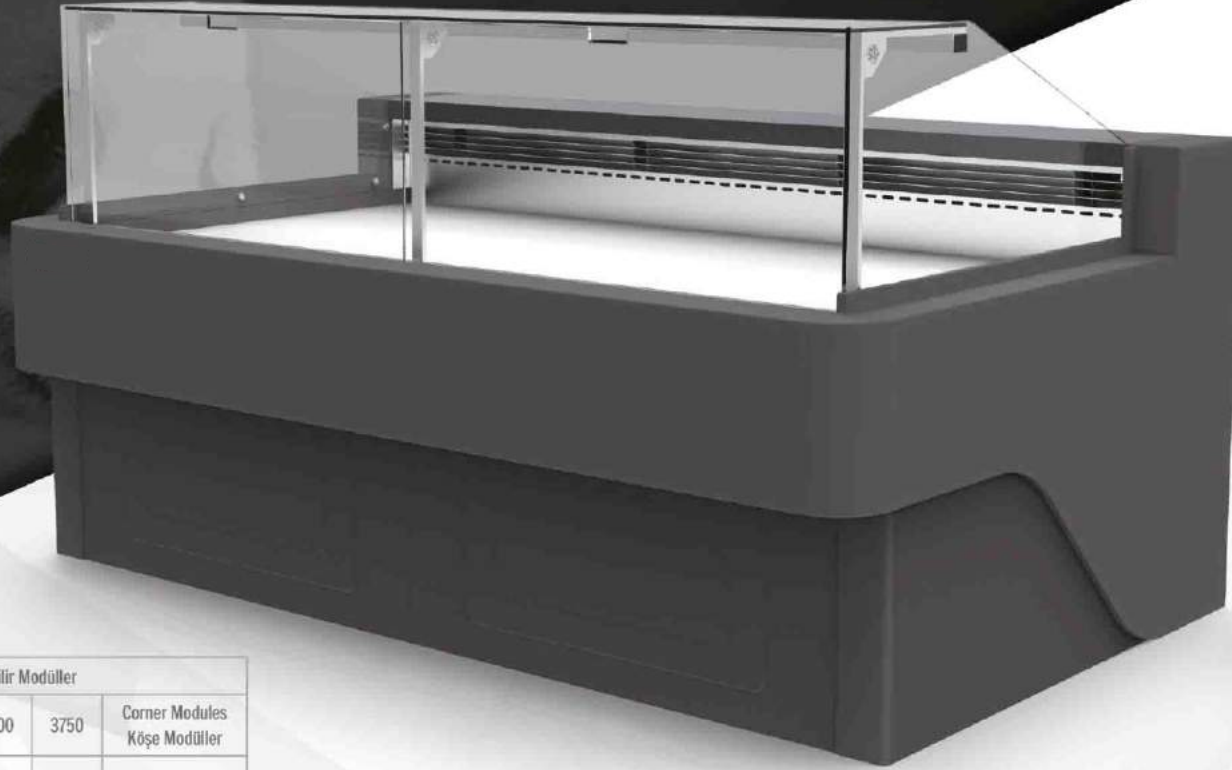

Available Modules / Kullanılabilir Modüller						
Length (mm) Uzunluk (mm)	937	1250	1875	2500	3750	Corner Modules Köşe Modülleri
Side panel (mm) Yan kapak (mm)	40	40	40	40	40	40

Operating Temperatures Çalışma Sıcaklıkları	Ambient Conditions Ortam Koşulları
M2 (-1/+7°C) - H1 (+1/+10°C)	25°C / 60% RH (EN ISO 23953-2)

Technical Specifications / Teknik Özellikler

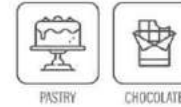
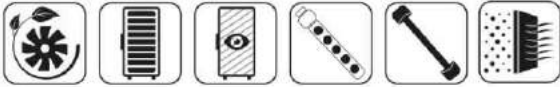

PANDA 900 FG/CB

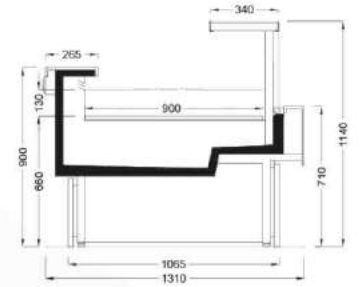

PANDA 800 FG/CB

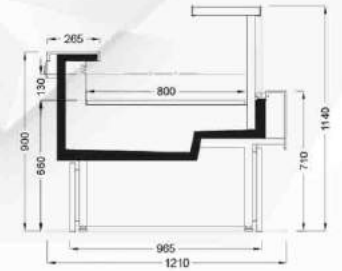

PANDA 700 FG/CB

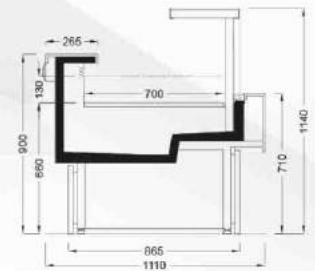

TORA



Semi Vertical Refrigerated Cabinet Connectable With Counters
Servis Reyonlarıyla Birleştirilebilir Yarı Dikey Soğutucu Reyon

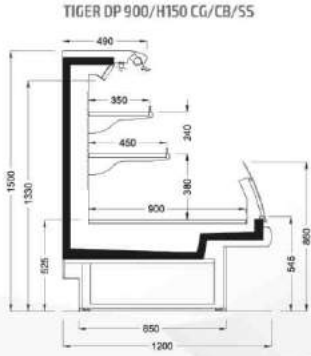

Available Modules / Kullanılabilir Modüller					
Length (mm) Uzunluk (mm)	937	1250	1875	2500	3750
Side panel (mm) Yan kapak (mm)	40	40	40	40	40

Operating Temperatures Çalışma Sıcaklıkları	Ambient Conditions Ortam Koşulları
M1 (-1/+5°C) - M2 (-1/+7°C)	25°C / 60% RH (EN ISO 23953-2)

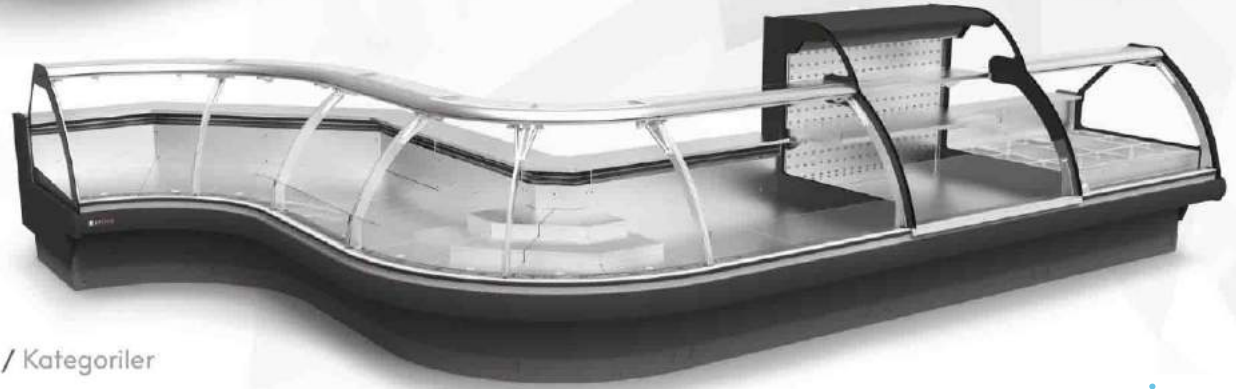

Technical Specifications / Teknik Özellikler



Categories / Kategoriler



DAIRY PRODUCTS DELICATESSEN DRINKS



Serve-Over Counters
Servis Reyonları

Refrigerated Serve-Over Counter With Storage

Depolu Soğutmalı Servis Reyonu



Available Modules / Kullanılabilir Modüller					
Length (mm) Uzunluk (mm)	937	1250	1875	2500	3750
Side panel (mm) Yan kapak (mm)	40	40	40	40	40

Operating Temperatures Çalışma Sıcaklıkları	Ambient Conditions Ortam Koşulları
M1 (-1/+5°C) - M2 (-1/+7°C)	25°C / 60% RH (EN ISO 23953-2)

Technical Specifications / Teknik Özellikler



Categories / Kategoriler

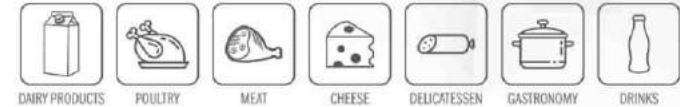

KANGAROO 900 CG/CB

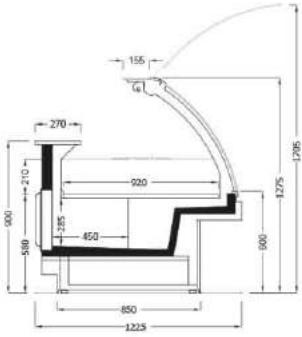

KANGAROO 800 CG/CB

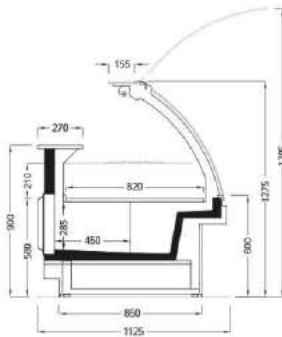

KANGAROO 900 FG/CB

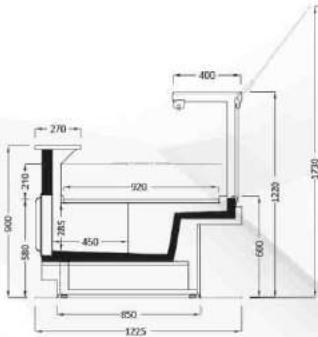

KANGAROO 800 FG/CB

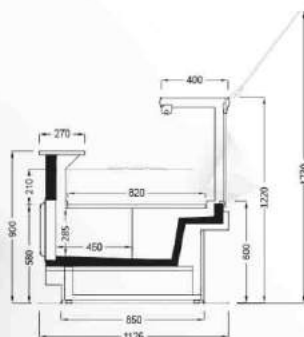

KANGAROO 900 IFG/CB

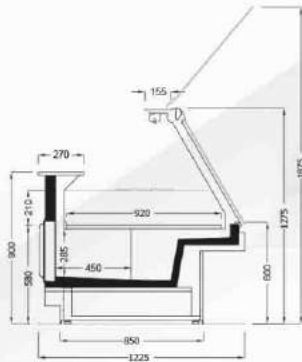

KANGAROO 800 IFG/CB

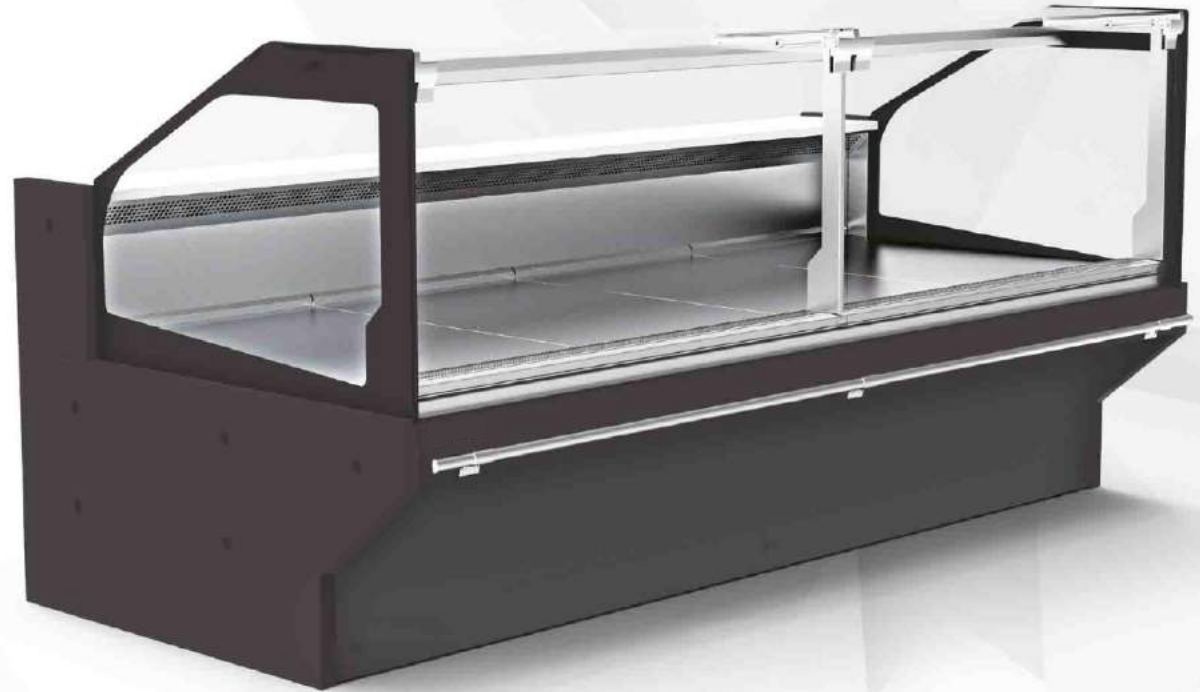
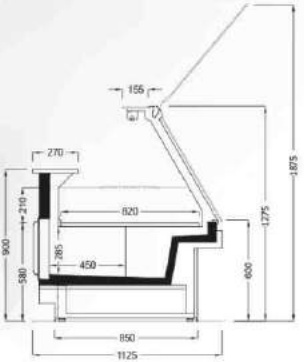

Serve-Over Counters
Servis Reyonları



TAYFUN COOLING
Soğutma Sanayi Tic.Ltd.Şti

Upright Glassed Freezer
Cam Kapılı Dikey Derin Dondurucu



SCORPION 90 / 220 / 205

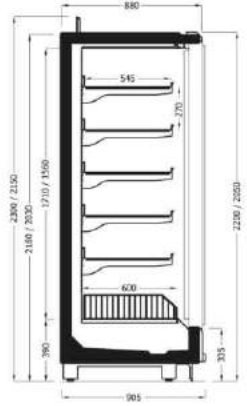

SCORPION 75 / 220 / 205

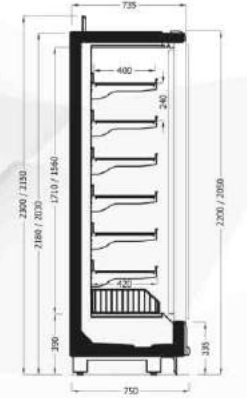

Available Modules / Kullanılabilir Modüller				
Length (mm) Uzunluk (mm)	2D	3D	4D	5D
Side panel (mm) Yan kapak (mm)	50	50	50	50

Operating Temperatures Çalışma Sıcaklıkları	Ambient Conditions Ortam Koşulları
L1 (-15/-18°C) - L2 (-12/-18°C)	25°C / 60% RH (EN ISO 23953-2)

Technical Specifications / Teknik Özellikler



Categories
Kategoriler



CYCLOME



Vertical Glass Door Combi Freezer
Cam Kapılı Dikey Kombi Derin Dondurucu

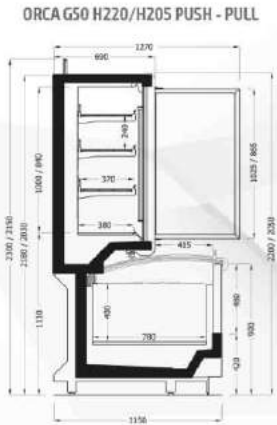
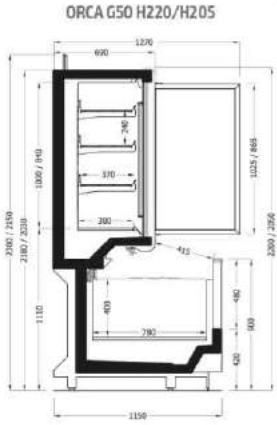

Available Modules / Kullanılabilir Modüller				
Length (mm) Uzunluk (mm)	3D 1875	4D 2500	5D 3750	Gondola / Head
Side panel (mm) Yan kapak (mm)	50	50	50	60

Operating Temperatures Çalışma Sıcaklıkları	Ambient Conditions Ortam Koşulları
L1 (-15/-18°C) - L2 (-12/-18°C)	25°C / 60% RH (EN ISO 23953-2)

Categories
Kategoriler



Technical Specifications / Teknik Özellikler

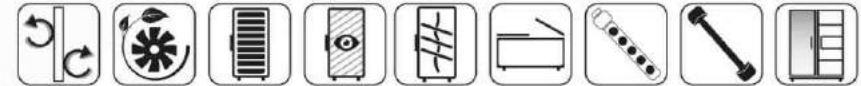

Upright Freezers
Dikey Dondurucu

Double Island Type Freezer Cabinets

Çift Yönlü Ada Tipi Derin Dondurucu Reyonlar



WHALE G50/200 PUSH - PULL

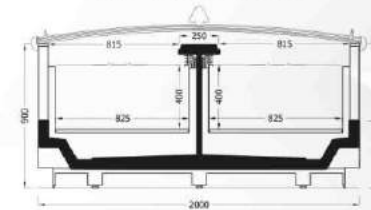

WHALE G50/150 PUSH - PULL

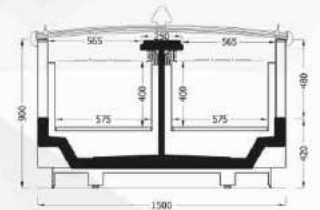

Available Modules / Kullanılabilir Modüller					
Length (mm) Uzunluk (mm)	1875	2500	3750	2000 HD	1500 HD
Side panel (mm) Yan kapak (mm)	60	60	60	60	60

Operating Temperatures Çalışma Sıcaklıkları	Ambient Conditions Ortam Koşulları
L1 (-15/-18°C) - L2 (-12/-18°C)	25°C / 60% RH (EN ISO 23953-2)

Technical Specifications / Teknik Özellikler



Categories Kategoriler



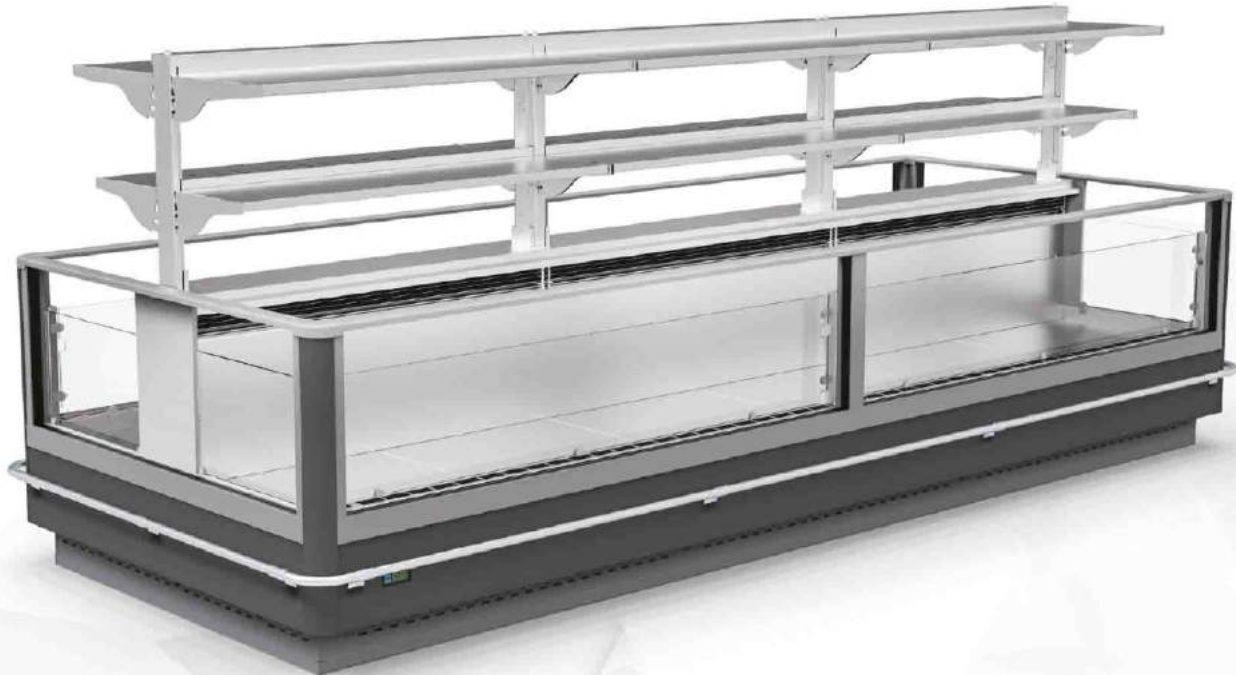

WHALE G50/200 S.S.

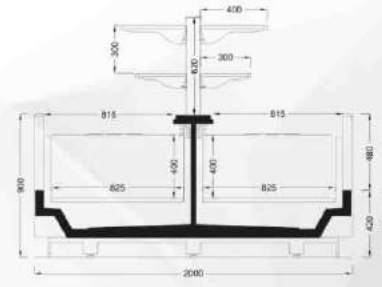

WHALE G50/150 S.S.

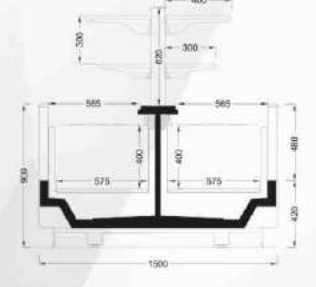

WHALE G50/200

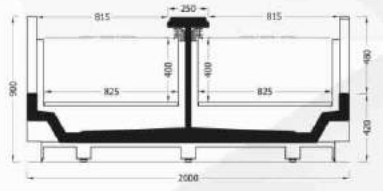

WHALE G50/150

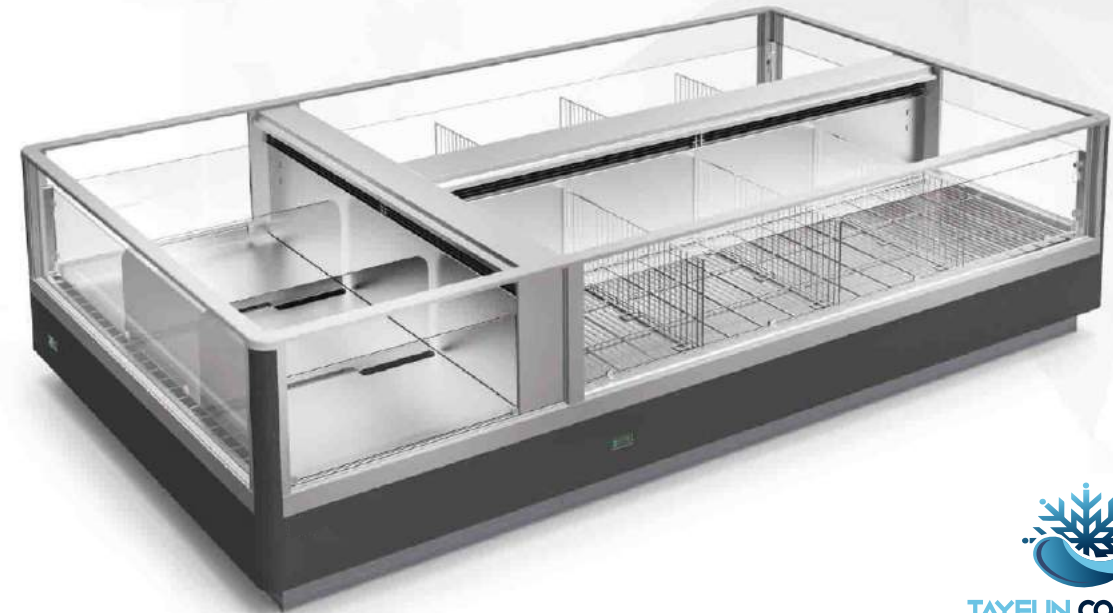
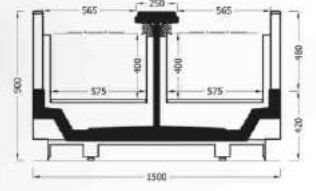

Island Freezers
Ada Tipi Doncurucu

Wall Type Freezer Cabinets

Duvar Tipi Derin Dondurucu Reyonlar



DOLPHIN WA/G50/110

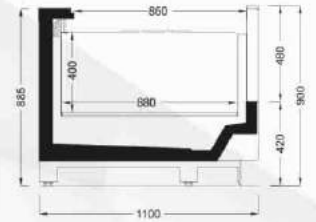

Available Modules / Kullanılabilir Modüller			
Length (mm) Uzunluk (mm)	1875	2500	3750
Side panel (mm) Yan kapak (mm)	60	60	60

Operating Temperatures Çalışma Sıcaklıkları	Ambient Conditions Ortam Koşulları
L1 (-15/-18°C) - L2 (-12/-18°C)	25°C / 60% RH (EN ISO 23953-2)

Technical Specifications / Teknik Özellikler

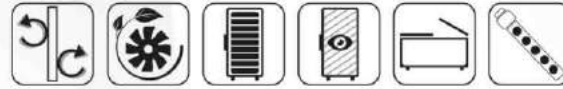

Categories
Kategoriler



FROZEN FOOD



ICE CREAM





DOLPHIN WA/G50/110 SLD

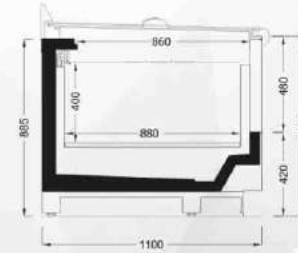

DOLPHIN WA/G50/110 PUSH-PULL SLD

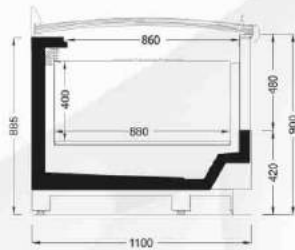

TAYFUN COOLING
Soğutma Sanayi Tic.Ltd.Şti

Single Island Type Freezer Cabinets

Tek Yönlü Ada Tipi Derin Dondurucu Reyonlar



Available Modules / Kullanılabilir Modüller			
Length (mm) Uzunluk (mm)	1875	2500	3750
Side panel (mm) Yan kapak (mm)	60	60	60

Operating Temperatures Çalışma Sıcaklıkları	Ambient Conditions Ortam Koşulları
L1 (-15/-18°C) - L2 (-12/-18°C)	25°C / 60% RH (EN ISO 23953-2)

Technical Specifications / Teknik Özellikler

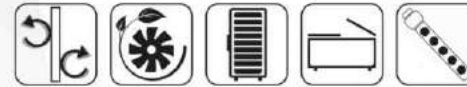

Categories Kategoriler



DOLPHIN IS/G20/T10

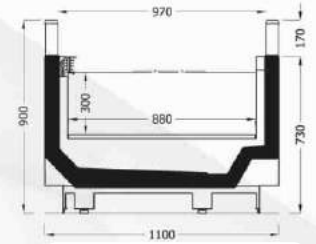

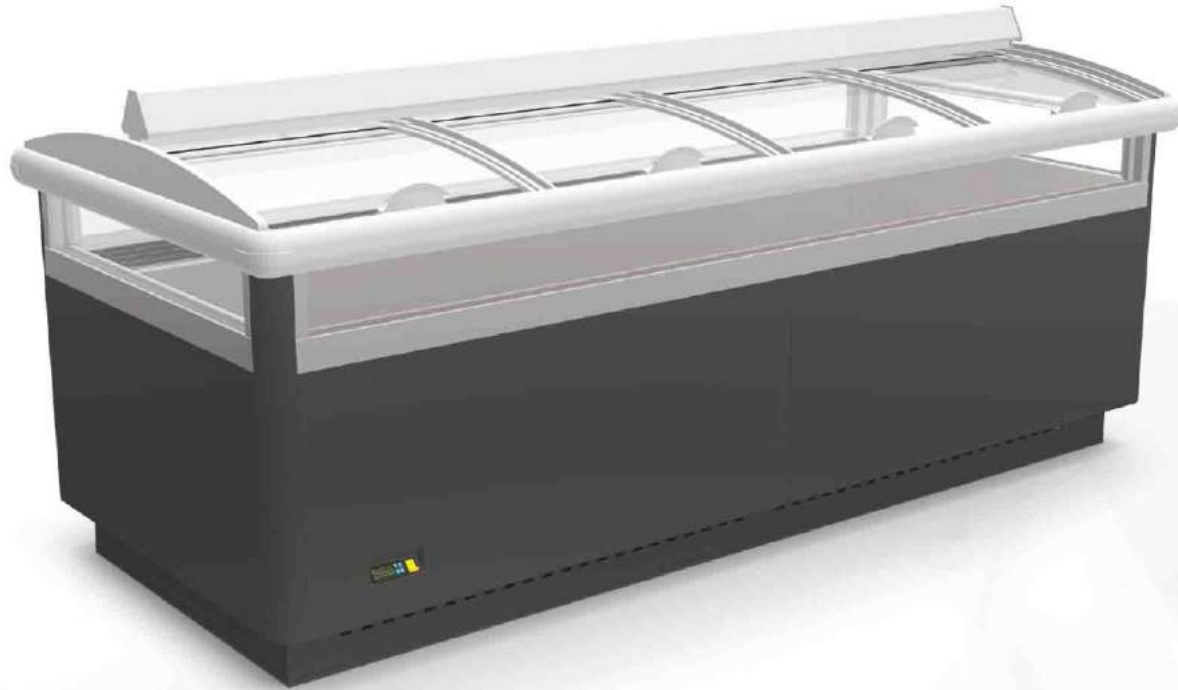

DOLPHIN IS/G20/T10 PUSH-PULL SLD

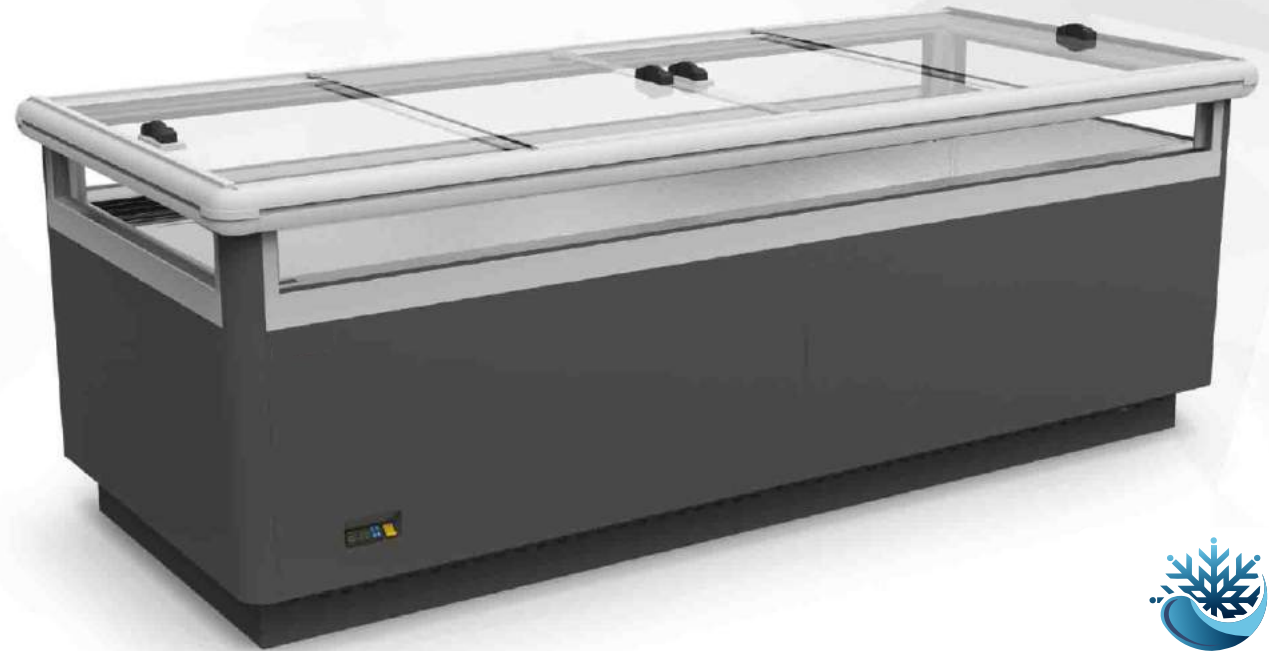
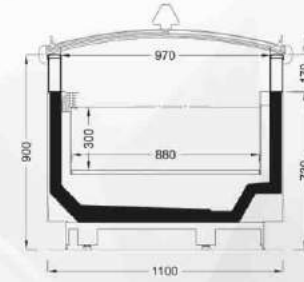

DOLPHIN IS/G20/T10 SLD

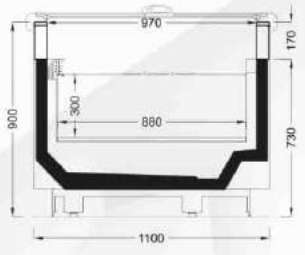

TAYFUN COOLING
Soğutma Sanayi Tic.Ltd.Şti

Freezer Serve-Over Counter
Derindondurucu Servis Reyonu



Operating Temperatures Çalışma Sıcaklıkları	Ambient Conditions Ortam Koşulları
L1 (-15/-18°C) - L2 (-12/-18°C)	25°C / 60% RH (EN ISO 23953-2)

Available Modules / Kullanılabilir Modüller			
Length/Uzunluk (mm)	1250	1875	2500
Side panel/ Yan kapak (mm)	70	70	70

Technical Specifications / Teknik Özellikler

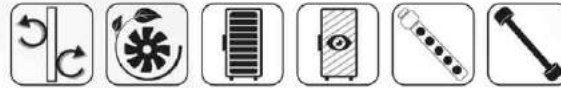

Categories Kategoriler



FROZEN FOOD



TAYFUN COOLING
Soğutma Sanayi Tic.Ltd.Şti

BARRACUDA FROZEN BOO FG PLUG-IN

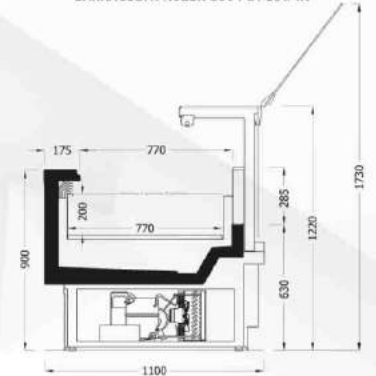

OLUJA FRESH FISH



Fresh Fish Serve-Over Counter
Taze Balık Servis Reyonu



BARRACUDA FRESH 800 FG PLUG-IN

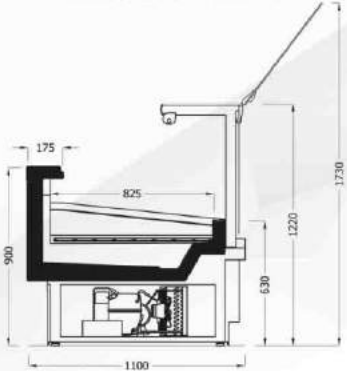

Categories
Kategoriler



FISH

Technical Specifications / Teknik Özellikler

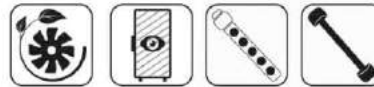

Operating Temperatures Çalışma Sıcaklıkları	Ambient Conditions Ortam Koşulları
M1 (-1/+5°C) - M2 (-1/+7°C)	25°C / 60% RH (EN ISO 23953-2)

Available Modules / Kullanılabilir Modüller			
Length/Uzunluk (mm)	1250	1875	2500
Side panel/ Yan kapak (mm)	50	50	50



Plug-in Ice Cream Serve Over Counter
İçten Motorlu Dondurma Servis Reyonu

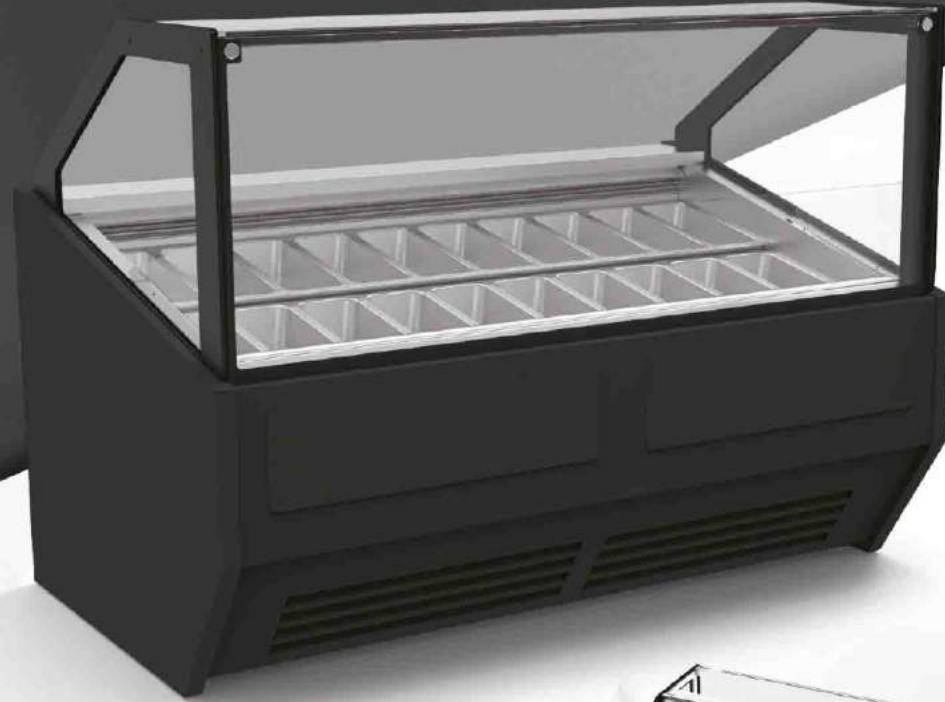

PENGUIN 110 FG

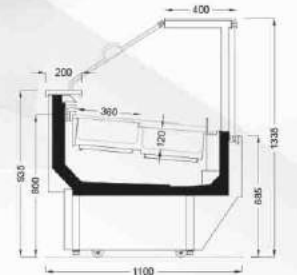

Available Modules / Kullanılabilir Modüller				
Length (mm) Uzunluk (mm)	1000	1330	1495	1825

Operating Temperatures Çalışma Sıcaklıkları	Ambient Conditions Ortam Koşulları
L1 (-15/-18°C) - L2 (-12/-18°C)	25°C / 60% RH (EN ISO 23953-2)

Technical Specifications / Teknik Özellikler

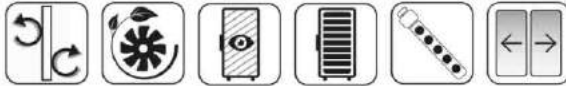

Categories
Kategoriler



ICE CREAM

TEMPESTA



Plug-in Refrigerated Island Type Freezer
İçten Motorlu Soğutmalı Ada Tipi Derin Dondurucu



Available Modules / Kullanılabilir Modüller		
Length (mm) Uzunluk (mm)	1500	2000
Operating Temperatures Çalışma Sıcaklıkları	Ambient Conditions Ortam Koşulları	
L1 (-15/-18°C) - L2 (-12/-18°C)	25°C / 60% RH (EN ISO 23953-2)	

OCTOPUS 110

OCTOPUS 110 SLD

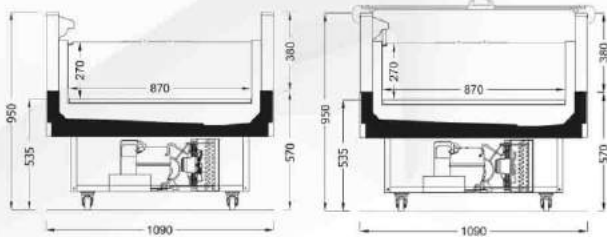

Categories
Kategoriler



FROZEN FOOD

ICE CREAM



Technical Specifications / Teknik Özellikler

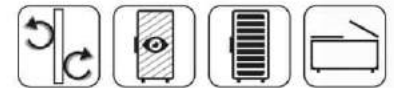

Plug-in Refrigerated Horizontal Promotion Cabinet
With Flat Glass

İçten Motorlu Soğutmalı Promosyon Reyonu
Düz Camlı



Available Modules / Kullanılabilir Modüller	
Length (mm) Uzunluk (mm)	1050
Operating Temperatures Çalışma Sıcaklıkları	Ambient Conditions Ortam Koşulları
M1 (-1/+5°C) - M2 (-1/+7°C)	25°C / 60% RH (EN ISO 23953-2)

Technical Specifications / Teknik Özellikler



Categories / Kategoriler



DAIRY PRODUCTS POULTRY CHEESE DELICATESSEN

CRAB 1050

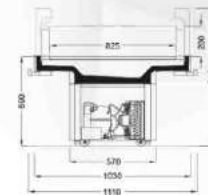

CRAB 800

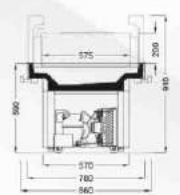

STURM



Plug-in Refrigerated Horizontal Promotion Cabinet
With Curved Glass

İçten Motorlu Soğutmalı Yatay Promosyon Reyonu
Bombe Camlı



Available Modules / Kullanılabilir Modüller	
Length (mm) Uzunluk (mm)	1050
Operating Temperatures Çalışma Sıcaklıkları	Ambient Conditions Ortam Koşulları
M1 (-1/+5°C) - M2 (-1/+7°C)	25°C / 60% RH (EN ISO 23953-2)

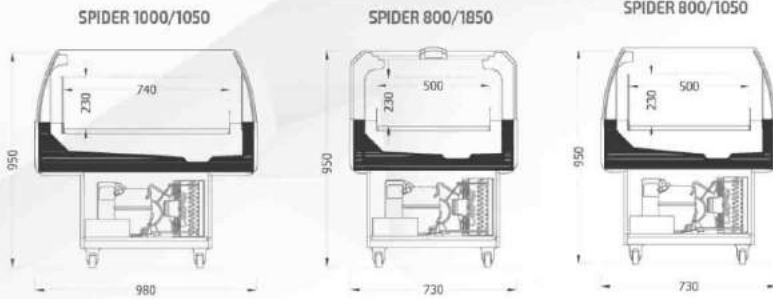

Categories / Kategoriler



DAIRY PRODUCTS POULTRY CHEESE DELICATESSEN

Technical Specifications / Teknik Özellikler



TAYFUN COOLING
Sogutma Sanayi Tic.Ltd.Sti

Plug-in Refrigerated Semi Vertical Promotion Cabinet
İçten Motorlu Soğutmalı Dikey Promosyon Reyonu

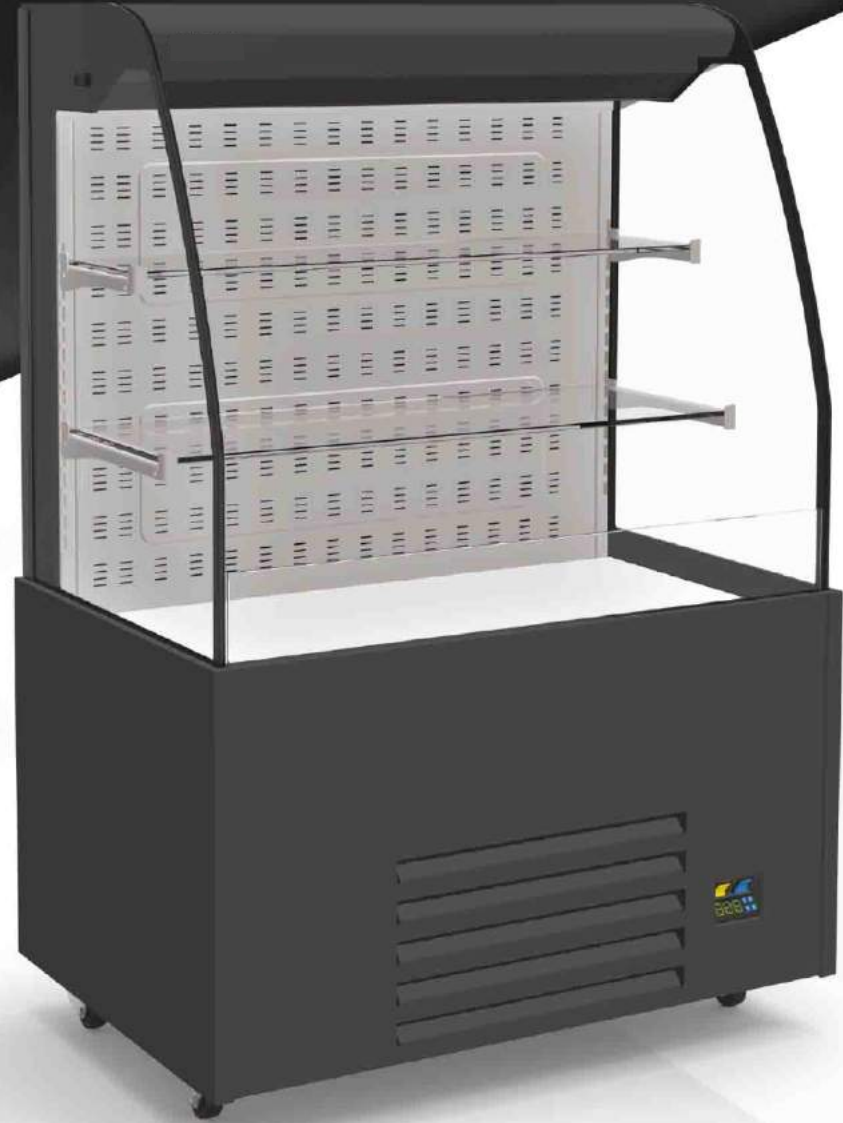

Available Modules / Kullanılabilir Modüller			
Length (mm) Uzunluk (mm)	730	970	1280

Operating Temperatures Çalışma Sıcaklıkları	Ambient Conditions Ortam Koşulları
M2 (-1/+7°C)	25°C / 60% RH (EN ISO 23953-2)

PHOENIX DP/75/140 V1

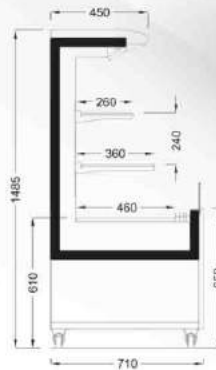

Technical Specifications / Teknik Özellikler

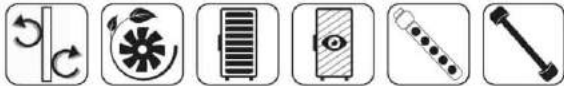

Categories / Kategoriler



FREDDO



Cold Drinks, Pastry Bakery & Hot-Cold Meal Display Cabinets
Soğuk İçecekler, Pasta, Unlu Mamül ve Sıcak-Soğuk Yemek Teşhir Reyonu



Categories / Kategoriler



TAYFUN COOLING
Sogutma Sanayi Tic.Ltd.Sti

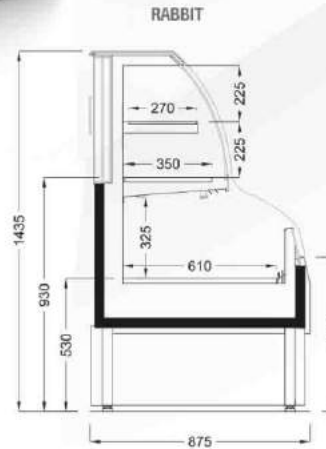

Available Modules / Kullanılabilir Modüller		
Length (mm) Uzunluk (mm)	937	1250
Side panel (mm) Yan kapak (mm)	40	40

Operating Temperatures Çalışma Sıcaklıkları	Ambient Conditions Ortam Koşulları
M2 (-1/+7°C)	25°C / 60% RH (EN ISO 23953-2)

Technical Specifications / Teknik Özellikler

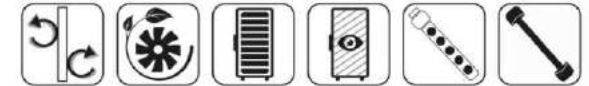

Plug-in Refrigerated Multideck
Duvar Tipi İçten Motorlu Soğutmalı Reyon

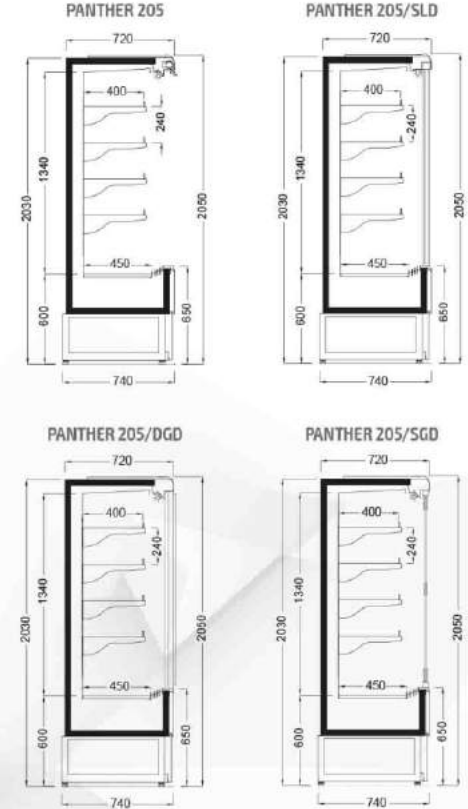

Available Modules / Kullanılabilir Modüller				
Length (mm) Uzunluk (mm)	937	1250	1875	2500
Side panel (mm) Yan kapak (mm)	40	40	40	40

Operating Temperatures Çalışma Sıcaklıkları	Ambient Conditions Ortam Koşulları
M1 (-1/+5°C) - M2 (-1/+7°C)	25°C / 60% RH (EN ISO 23953-2)

Technical Specifications / Teknik Özellikler



Categories / Kategoriler

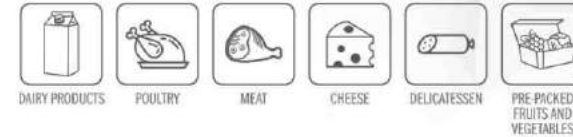

DRY-AGED



Plug-in Refrigerated Meat Dry Aging Cabined
Duvar Tipi İçten Motorlu Soğutmalı Et Yaşlandırma Dolabı



DRY AGE 800/H210

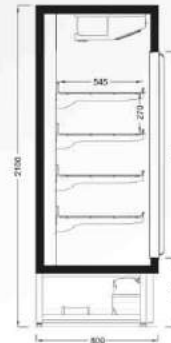

Available Modules / Kullanılabilir Modüller		
Length (mm) Uzunluk (mm)	1D 900	2D 1680
Operating Temperatures Çalışma Sıcaklıkları	Ambient Conditions Ortam Koşulları	
M1 (-1/+5°C)	25°C / 60% RH (EN ISO 23953-2)	

Technical Specifications / Teknik Özellikler

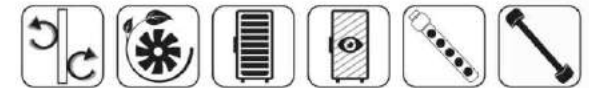

TAYFUN COOLING
Soğutma Sanayi Tic.Ltd.Sti

Categories
Kategoriler



MEAT

Plug-in Refrigerated Open Multideck

Duvar Tipi İçten Motorlu Soğutmalı Açık Reyon

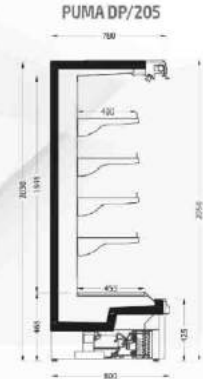

Available Modules / Kullanılabilir Modüller				
Length (mm) Uzunluk (mm)	937	1250	1875	2500
Side panel (mm) Yan kapak (mm)	40	40	40	40

Operating Temperatures Çalışma Sıcaklıkları	Ambient Conditions Ortam Koşulları
M1 (-1/+5°C) - M2 (-1/+7°C)	25°C / 60% RH (EN ISO 23953-2)

Technical Specifications / Teknik Özellikler



TAYFUN COOLING
Soğutma Sanayi Tic.Ltd.Sti

Categories / Kategoriler

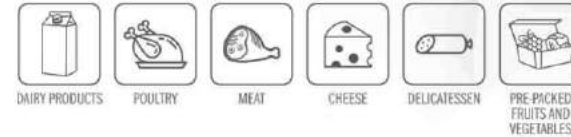

HURACAM SDG

Plug-in Refrigerated Multideck / Single Glass Hinged Door

Duvar Tipi İçten Motorlu Soğutmalı / Tek Camlı Çarpma Kapılı Reyon

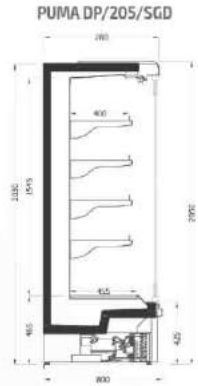

Operating Temperatures Çalışma Sıcaklıkları	Ambient Conditions Ortam Koşulları
M1 (-1/+5°C) - M2 (-1/+7°C)	25°C / 60% RH (EN ISO 23953-2)

Available Modules / Kullanılabilir Modüller				
Length (mm) Uzunluk (mm)	937	1250	1875	2500
Side panel (mm) Yan kapak (mm)	40	40	40	40

HURACAM DGD/SLD

Plug-in Refrigerated Multideck / Double Glass Hinged Door / Sliding Door

Duvar Tipi İçten Motorlu Soğutmalı / İki Camlı Çarpma Kapılı / Sürgü Kapılı Reyon

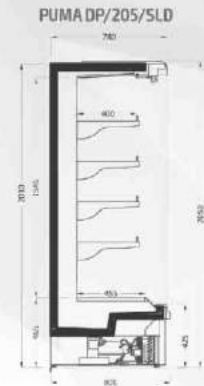
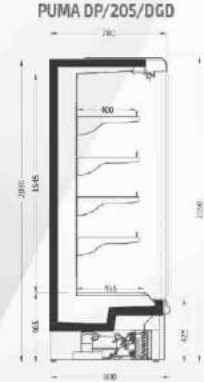

Operating Temperatures Çalışma Sıcaklıkları	Ambient Conditions Ortam Koşulları
M1 (-1/+5°C) - M2 (-1/+7°C)	25°C / 60% RH (EN ISO 23953-2)

Available Modules / Kullanılabilir Modüller				
Length (mm) Uzunluk (mm)	937	1250	1875	2500
Side panel (mm) Yan kapak (mm)	40	40	40	40

Plug-in Vertical Glazed Freezer

İçten Motorlu Dikey Derin Dondurucu Reyon

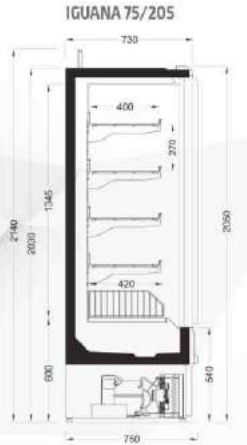

Available Modules / Kullanılabilir Modüller			
Length (mm) Uzunluk (mm)	2D	3D	4D
	1250	1875	2500
Side panel (mm) Yan kapak (mm)	50	50	50

Operating Temperatures Çalışma Sıcaklıkları	Ambient Conditions Ortam Koşulları
L1 (-15/-18°C) - L2 (-12/-18°C)	25°C / 60% RH (EN ISO 23953-2)

Technical Specifications / Teknik Özellikler

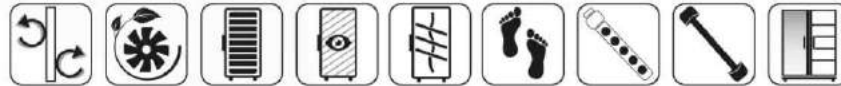

Categories
Kategoriler



Plug-in Semivertical Refrigerated Cabinet
İçten Motorlu Yarı Dikey Soğutucu Reyon

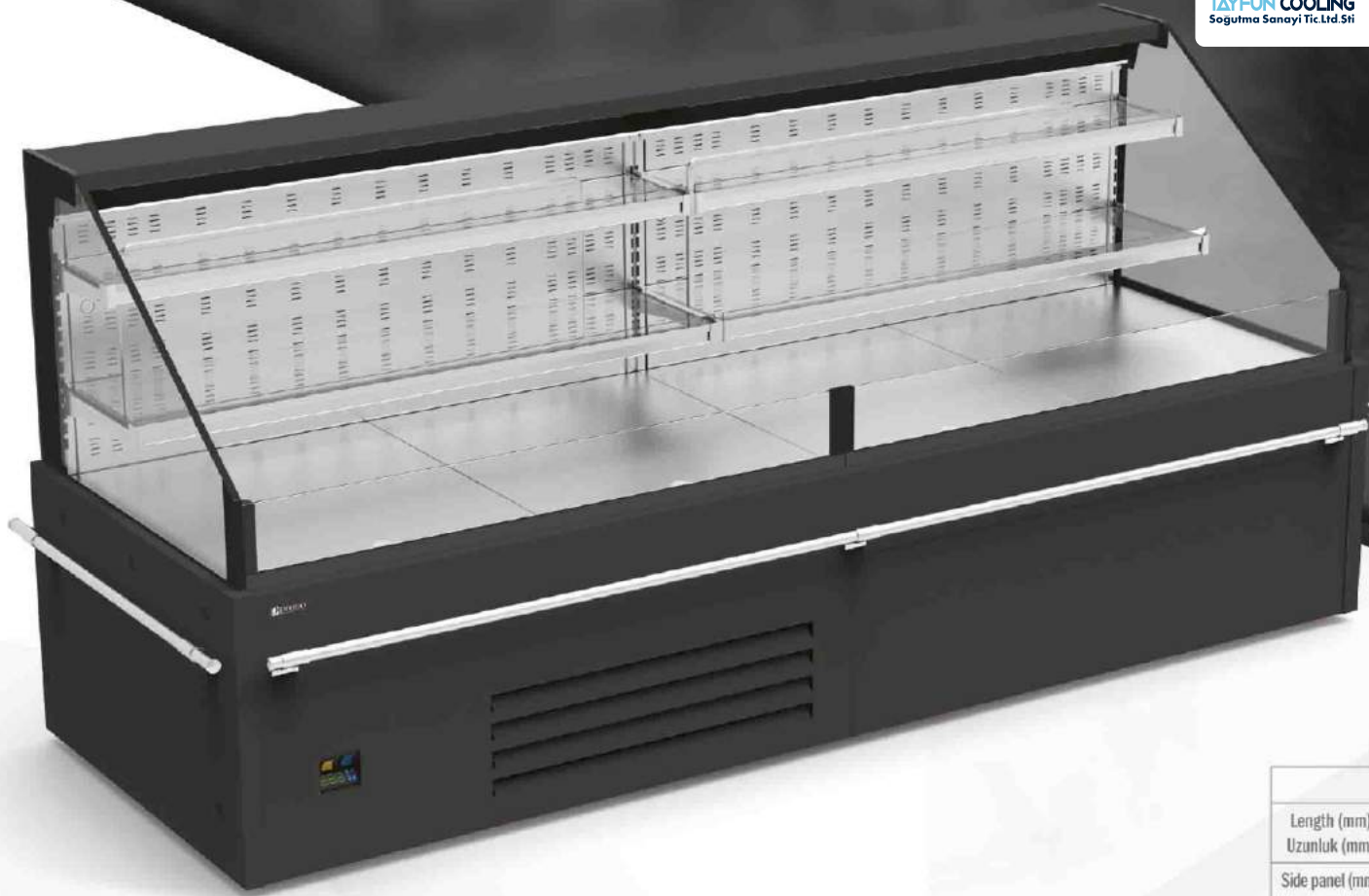

Categories / Kategoriler



DAIRY PRODUCTS POULTRY MEAT CHEESE GASTRONOMY SUSHI

FOX 90/117

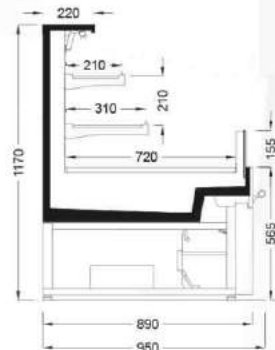

Available Modules / Kullanılabilir Modüller			
Length (mm) Uzunluk (mm)	1250	1875	2500
Side panel (mm) Yan kapak (mm)	40	40	40

Operating Temperatures Çalışma Sıcaklıkları	Ambient Conditions Ortam Koşulları
M1 (-1/+5°C) - M2 (-1/+7°C)	25°C / 60% RH (EN ISO 23953-2)

Technical Specifications / Teknik Özellikler

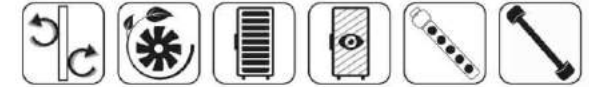

TORNADO

Plug-in Refrigerated Serve-Over Counter
İçten Motorlu Soğutmalı Servis Reyonu



Available Modules / Kullanılabilir Modüller				
Length (mm) Uzunluk (mm)	937	1250	1875	2500
Side panel (mm) Yan kapak (mm)	40	40	40	40

Operating Temperatures Çalışma Sıcaklıkları	Ambient Conditions Ortam Koşulları
M1 (-1/+5°C) - M2 (-1/+7°C)	25°C / 60% RH (EN ISO 23953-2)

Technical Specifications / Teknik Özellikler



Categories / Kategoriler

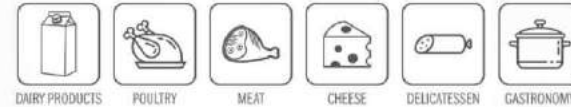

LEOPARD 800 CG

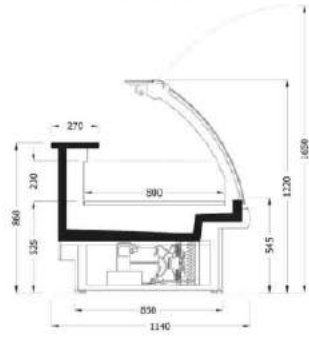

LEOPARD 800 IFG

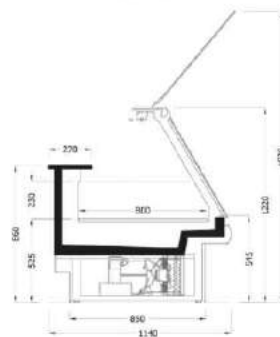

LEOPARD 800 FG

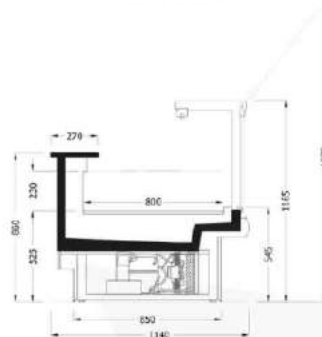

LEOPARD 900 CG



LEOPARD 900 FG

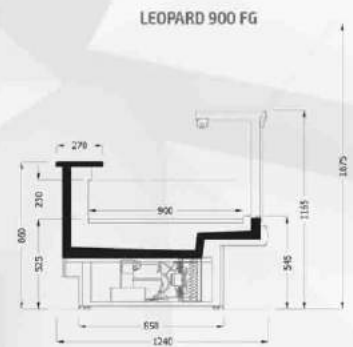

LEOPARD 900 IFG



TWISTER PLUG-IN

Plug-in Refrigerated Semi Vertical Cabinet
İçten Motorlu Yarı Dikey Soğutucu Reyon

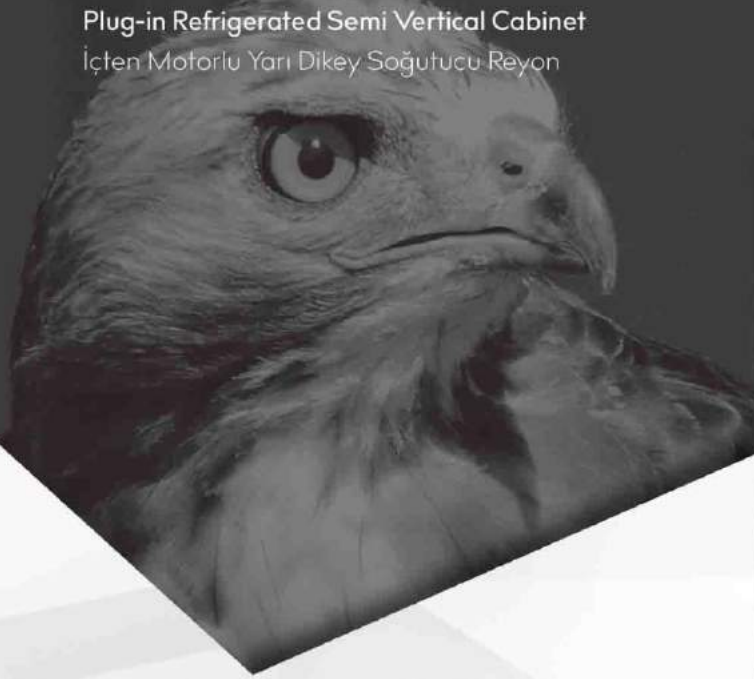

FALCON DP/110/140 PLUG-IN

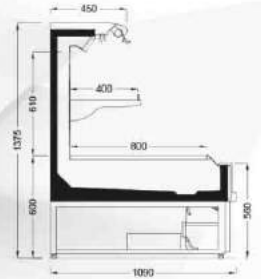

FALCON DP/100/150 PLUG-IN

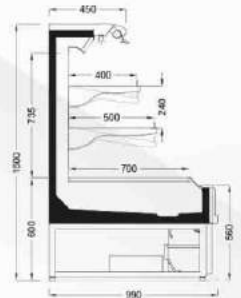

Available Modules / Kullanılabilir Modüller			
Length/Uzunluk (mm)	1250	1875	2500
Side panel/ Yan kapak (mm)	40	40	40

Operating Temperatures / Çalışma Sıcaklıkları		Ambient Conditions Ortam Koşulları
DP	MT	
M2 (-1/+7°C)	M1 (-1/+5°C)	25°C / 60% RH (EN ISO 23953-2)

Technical Specifications / Teknik Özellikler



Categories / Kategoriler

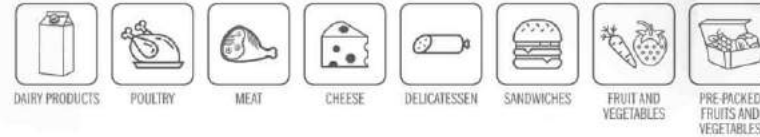

Plug-in Refrigerated Carcass Meat Display Cabinet
İçten Motorlu Soğutmalı Karkas Et Teşhir Reyonu



BUFFALO 75/H235



Available Modules / Kullanılabilir Modüller			
Length/Uzunluk (mm)	1250	1562	1875
Side panel/ Yan kapak (mm)	60	60	60

Operating Temperatures / Çalışma Sıcaklıkları		Ambient Conditions Ortam Koşulları
DP	MT	
M2 (-1/+7°C)	M1 (-1/+5°C)	25°C / 60% RH (EN ISO 23953-2)



Pastry, Bakery & Hot-Cold Meal Display Cabinets

Pasta, Unlu Mamül ve Sıcak-Soğuk Yemek Teshir Rayonları

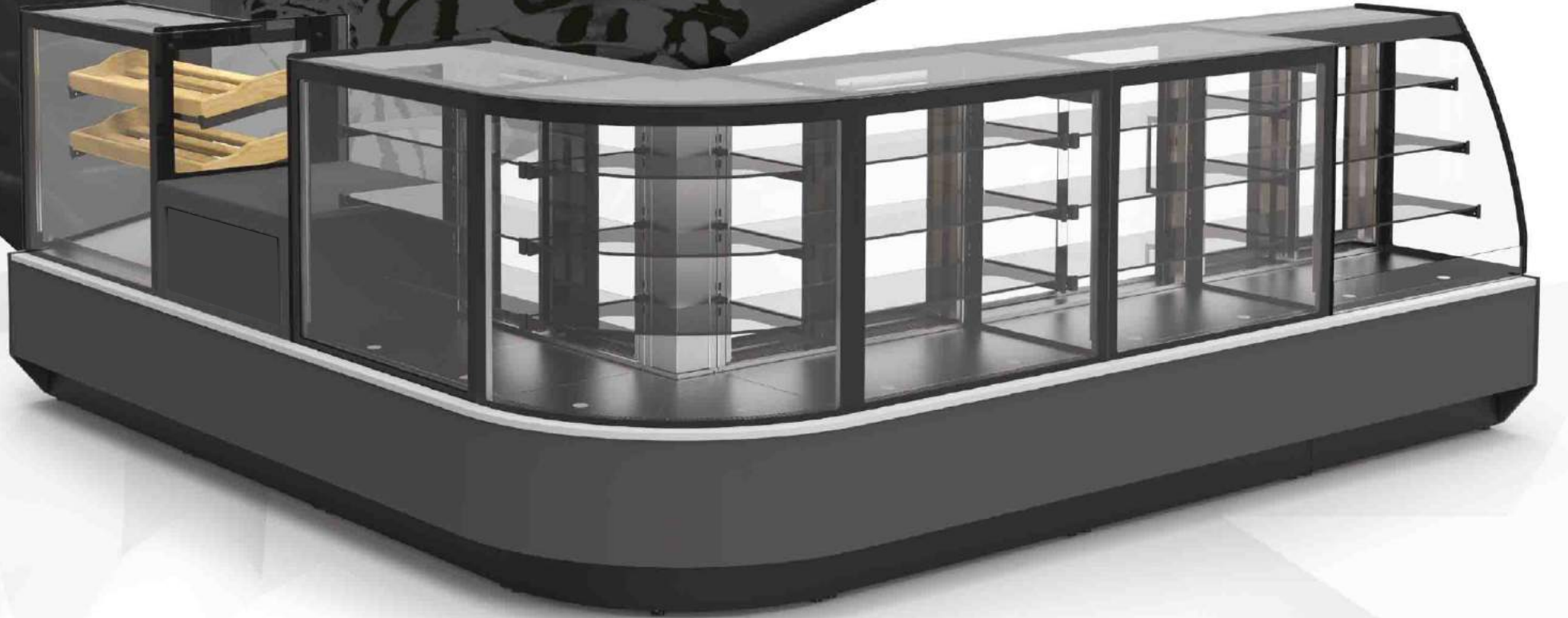

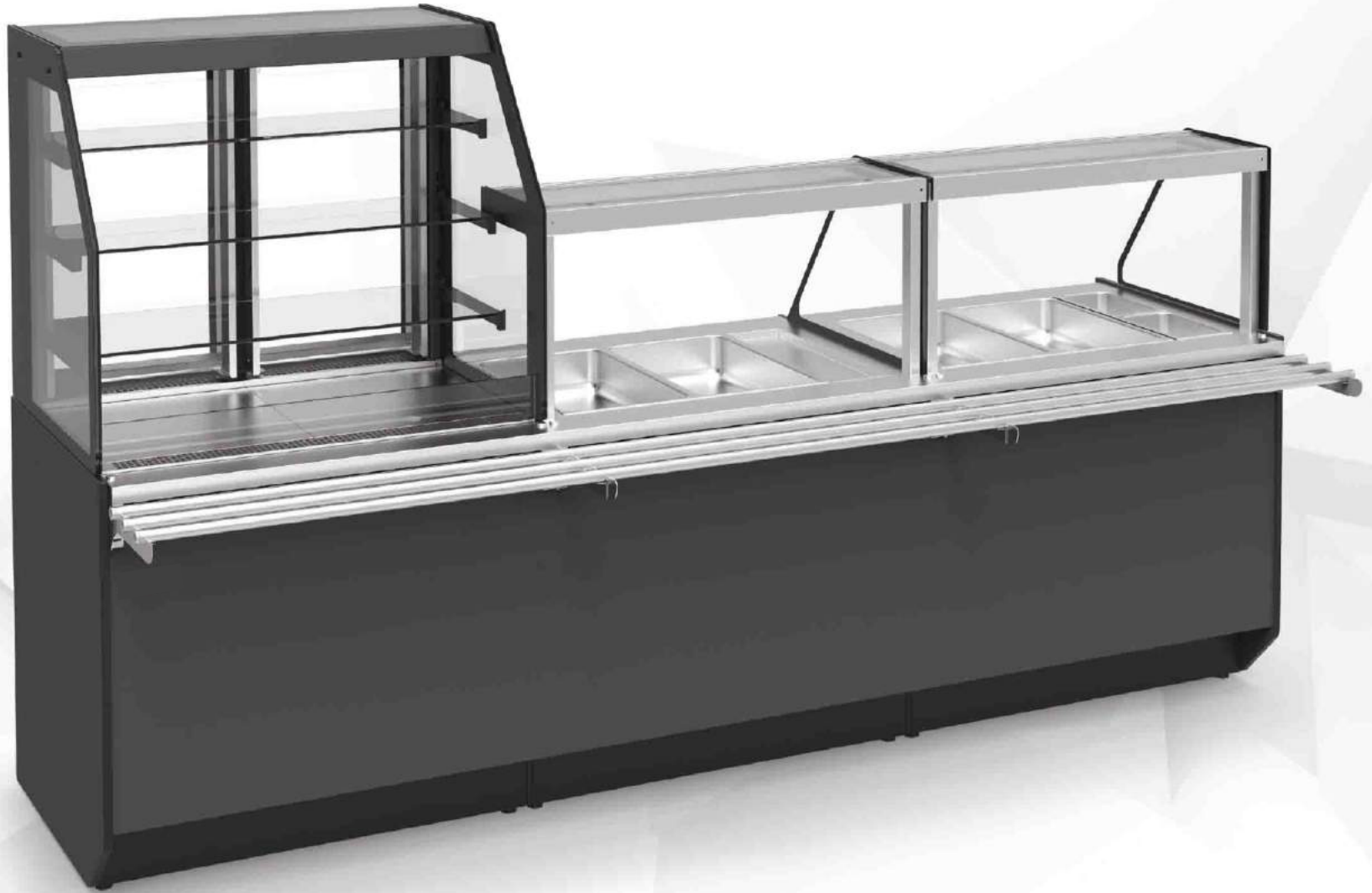

TAYFUN COOLING
Soğutma Sanayi Tic.Ltd.Sti

Plug-in Refrigerated Pastry Cabinet
İçten Motorlu Soğutmalı Pasta Reyonu



Categories
Kategoriler



PASTRY

DRINKS

Technical Specifications / Teknik Özellikler

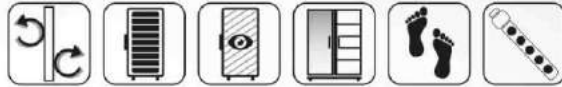

Available Modules / Kullanılabilir Modüller			Operating Temperatures Çalışma Sıcaklıkları	Ambient Conditions Ortam Koşulları
Length (mm) Uzunluk (mm)	937	1250		
Side panel (mm) Yan kapak (mm)	30	30		

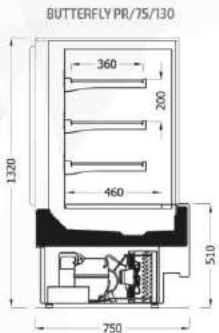

Neutral Pastry Cabinet
Nötr Pasta Reyonu



Categories
Kategoriler



CAKE

BAKED PRODUCT

Technical Specifications Tehnik Özellikler

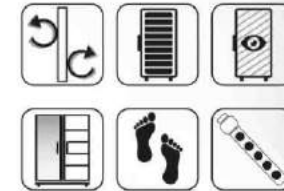

Available Modules / Kullanılabilir Modüller		
Length (mm) Uzunluk (mm)	937	1250
Side panel (mm) Yan kapak (mm)	30	30

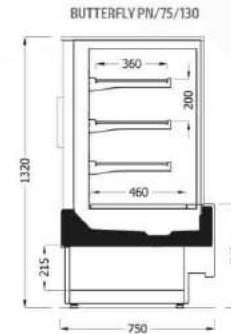

ARASHİ DP

Plug-in Refrigerated Open Cabinet
İçten Motorlu Soğutmalı Açık Reyon



Categories
Kategoriler



Technical Specifications / Teknik Özellikler

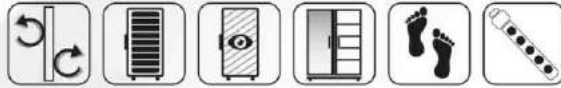

Available Modules / Kullanılabilir Modüller			Operating Temperatures Çalışma Sıcaklıkları	Ambient Conditions Ortam Koşulları
Length (mm) Uzunluk (mm)	937	1250		
Side panel (mm) Yan kapak (mm)	30	30		

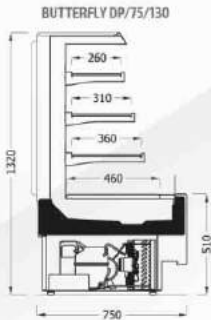

ARASHİ TK

Plug-in Refrigerated Kebap Cabinet
İçten Motorlu Soğutmalı Kebap Reyonu



Categories
Kategoriler



Technical Specifications / Teknik Özellikler

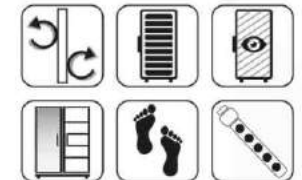

Available Modules / Kullanılabilir Modüller			Operating Temperatures Çalışma Sıcaklıkları	Ambient Conditions Ortam Koşulları
Length (mm) Uzunluk (mm)	937	1250		
Side panel (mm) Yan kapak (mm)	30	30		

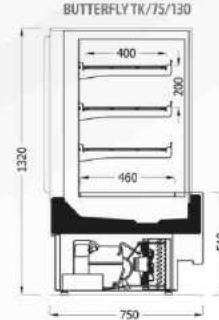

Plug-in Refrigerated Combined Pastry Cabinet
İçten Motorlu Soğutmalı Kombine Pasta Reyonu



Operating Temperatures Çalışma Sıcaklıkları	Ambient Conditions Ortam Koşulları
M2 (-1/+7°C)	25°C / 60% RH (EN ISO 23953-2)

Available Modules / Kullanılabilir Modüller		
Length (mm) Uzunluk (mm)	1330	1955

Technical Specifications / Teknik Özellikler

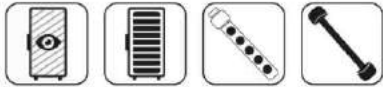

Categories / Kategoriler



PASTRY

CAKE

DRINKS

BAKED PRODUCT



TAYFUN COOLING
Soğutma Sanayi Tic.Ltd.Şti

BUTTERFLY MFT 75/150

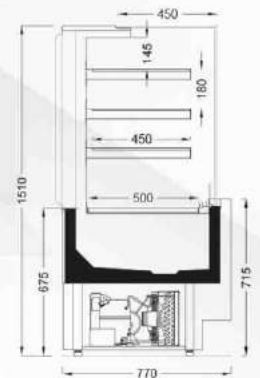

ARASHİ CG "PR / PN / HT"

Plug-in Refrigerated Cabinet With Curved Glass
İçten Motorlu Soğutmalı Bombe Camlı Reyon

Natural Cabinet With Curved Glass
Nöfr Bombe Camlı Reyon

Heated Cabinet With Curved Glass
Isıtmalı Bombe Camlı Reyon



Available Modules / Kullanılabilir Modüller			
Length/Uzunluk (mm)	625	937	1250
Side panel/ Yan kapak (mm)	30	30	30

Operating Temperatures Çalışma Sıcaklıkları	Ambient Conditions Ortam Koşulları
M2 (-1/+7 C°)	25°C / 60% RH (EN ISO 23953-2)

BUTTERFLY PR/CG/110/140

BUTTERFLY PR/CG/90/130

BUTTERFLY PR/CG/75/130

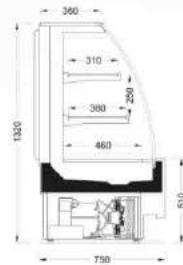
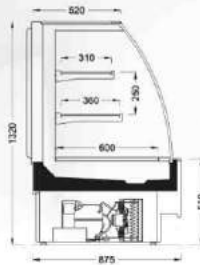
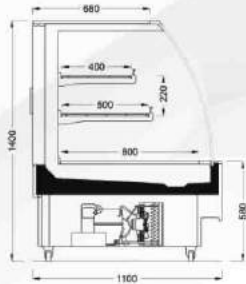

Categories / Kategoriler



PASTRY

CAKE

DRINKS

BAKED PRODUCT

Technical Specifications / Teknik Özellikler



TAYFUN COOLING
Soğutma Sanayi Tic.Ltd.Sti

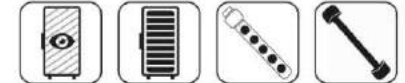

Bain-Marie Cabinet
Bain-Marie Reyonu



Technical Specifications / Teknik Özellikler



Categories
Kategoriler



HOT MEAL

BUTTERFLY BM/75/130



Available Modules / Kullanılabilir Modüller		
Length (mm) Uzunluk (mm)	937	1250
Side panel (mm) Yan kapak (mm)	30	30

Operating Temperatures Çalışma Sıcaklıkları	Ambient Conditions Ortam Koşulları
(+30/+90 °C)	25°C / 60% RH (EN ISO 23953-2)

ARASHİ SB



Plug-in Refrigerated Salad-Bar Cabinet
İçten Motorlu Soğutmalı Salat Bar Reyonu



Available Modules / Kullanılabilir Modüller

Length (mm) Uzunluk (mm)	937	1250
Side panel (mm) Yan kapak (mm)	30	30

Operating Temperatures Çalışma Sıcaklıkları

M2 (-1/+7 C°)	Ambient Conditions Ortam Koşulları 25°C / 60% RH (EN ISO 23953-2)
---------------	--

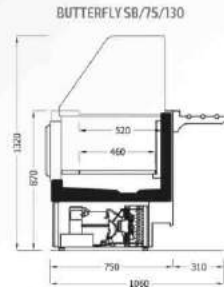

Categories
Kategoriler



COLD MEAL

Technical Specifications / Teknik Özellikler



TAYFUN COOLING
Sogutma Sanayi Tic.Ltd.Sti

Hot Plate Cabinet
Kuru Isıtmalı Reyonu

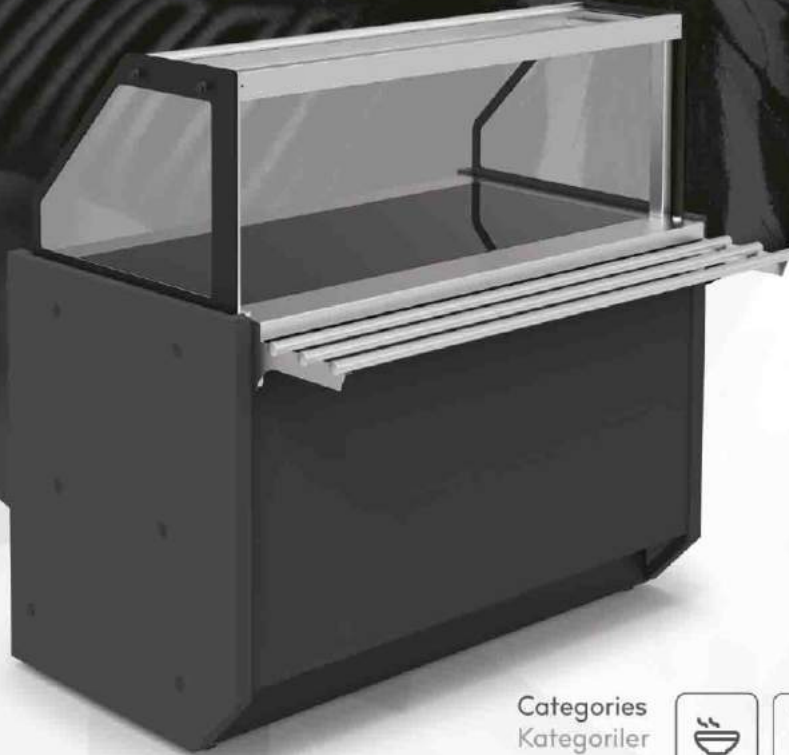

Categories
Kategoriler



HOT MEAL

PIZZA

Technical Specifications / Teknik Özellikler

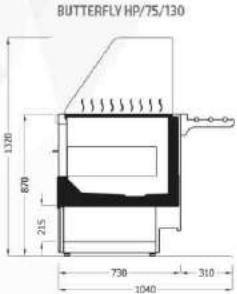

Available Modules / Kullanılabilir Modüller		
Length (mm) Uzunluk (mm)	937	1250
Side panel (mm) Yan kapak (mm)	30	30

Operating Temperatures Çalışma Sıcaklıkları	Ambient Conditions Ortam Koşulları	
(+30/+90 C°)	25°C / 60% RH (EN ISO 23953-2)	

Plug-in Refrigerated Open Cabinet
İçten Motorlu Soğutmalı Açık Reyon



TAYFUN COOLING
Soğutma Sanayi Tic.Ltd.Sti

Categories
Kategoriler



DAIRY PRODUCTS

DRINKS

Technical Specifications / Teknik Özellikler

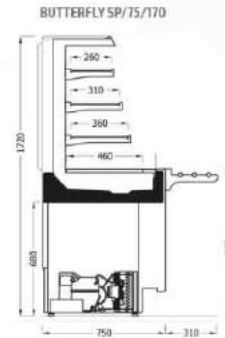
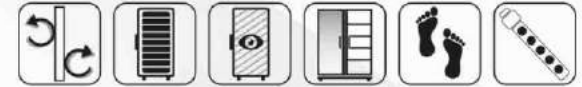

Available Modules / Kullanılabilir Modüller		
Length (mm) Uzunluk (mm)	937	1250
Side panel (mm) Yan kapak (mm)	30	30

Operating Temperatures Çalışma Sıcaklıkları	Ambient Conditions Ortam Koşulları	
M2 (-1/+7 C°)	25°C / 60% RH (EN ISO 23953-2)	

ARASHİ BR

Bread Display Cabinet
Ekmek Teşhir Reyonu



ARASHİ BR

Banco / Banko



TAYFUN COOLING
Soğutma Sanayi Tic.Ltd.Şti

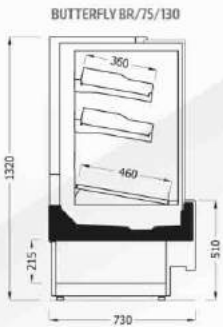

Categories
Kategoriler



CAKE



BAKED PRODUCT

Technical Specifications
Teknik Özellikler



Available Modules / Kullanılabilir Modüller		
Length (mm) Uzunluk (mm)	937	1250
Side panel (mm) Yan kapak (mm)	30	30

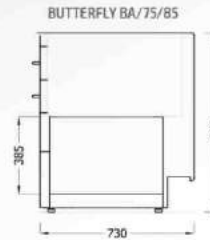

Technical Specifications
Teknik Özellikler



Available Modules / Kullanılabilir Modüller				
Length (mm) Uzunluk (mm)	600	800	1000	1200
Side panel (mm) Yan kapak (mm)	30	30	30	30

ARASHİ BUTTERFLY DVN "PR / PN"

Plug-in Refrigerated Pastry Cabinet
İçten Motorlu Soğutmalı Pasta Reyonu

Neutral Pastry Cabinet
Nötr Pasta Reyonu



Technical Specifications / Teknik Özellikler



Categories / Kategoriler



PAstry DRINKS CAKE BAKED PRODUCT

Operating Temperatures Çalışma Sıcaklıkları	Ambient Conditions Ortam Koşulları
M2 (-1/+7°C)	25°C / 60% RH (EN ISO 23953-2)

Available Modules / Kullanılabilir Modüller		
Length (mm) Uzunluk (mm)	937	1250
Side panel (mm) Yan kapak (mm)	30	30

BUTTERFLY PN/SP/DVN/75/150

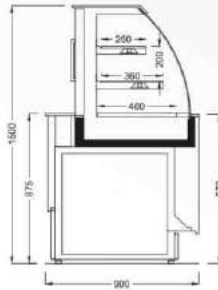

CHUUN®



TAYFUN COOLING
Soğutma Sanayi Tic.Ltd.Sti

Plug-in Refrigerated Vertical Pastry Cabinet
İçten Motorlu Soğutmalı Dikey Pasta Reyonu



FLAMINGO 75/200

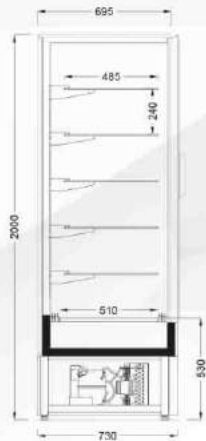

Categories
Kategoriler



PAstry

Technical Specifications / Teknik Özellikler



TAYFUN COOLING
Soğutma Sanayi Tic.Ltd.Sti

Available Modules / Kullanılabilir Modüller

Length (mm) Uzunluk (mm)	700	1400

Operating Temperatures
Çalışma Sıcaklıkları

Ambient Conditions
Ortam Koşulları

M2 (-1/+7 C°)

25°C / 60% RH
(EN ISO 23953-2)

Pastry, Bakery & Hot-Cold Meal Display Cabinets

Pasta, Unlu Mamül ve Sıcak-Soğuk Yemek Teşhir Reyonları





TAYFUN COOLING
Soğutma Sanayi Tic.Ltd.Sti

Neutral Pastry Cabinet
Nötr Pasta Reyonu



FIREFLY PN V1/75/130

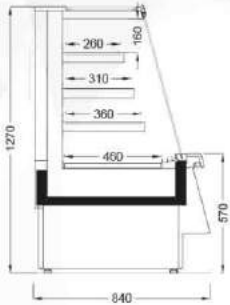

Technical Specifications Teknik Özellikler

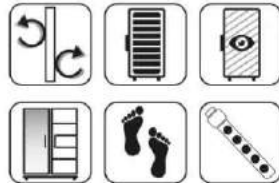

Categories / Kategoriler



Available Modules / Kullanılabilir Modüller		
Length (mm) Uzunluk (mm)	937	1250
Side panel (mm) Yan kapak (mm)	30	30

Plug-in Refrigerated Pastry Cabinet
İçten Motorlu Soğutmalı Pasta Reyonu



FIREFLY PR V1/75/130

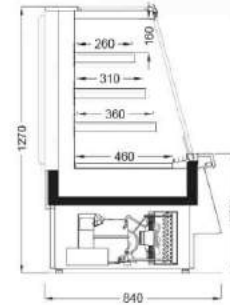

Technical Specifications Teknik Özellikler

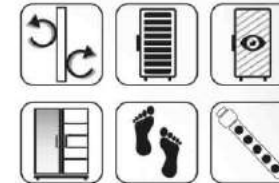

Categories Kategoriler



Available Modules / Kullanılabilir Modüller		
Length (mm) Uzunluk (mm)	937	1250
Side panel (mm) Yan kapak (mm)	30	30

Operating Temperatures Çalışma Sıcaklıkları	Ambient Conditions Ortam Koşulları
M2 (-1/+7 C°)	25°C / 60% RH (EN ISO 23953-2)

BUZ CORNERS

IC 90° / OC 90° / PR / PN



FIREFLY PN OC 90°/75

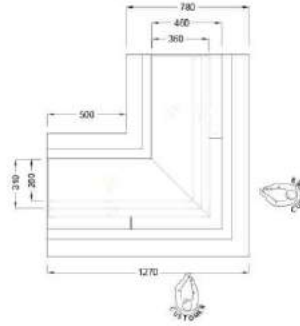

FIREFLY PR OC 90°/75

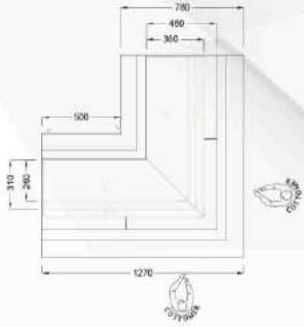

Technical Specifications Teknik Özellikler



Available Modules / Kullanılabilir Modüller		
Length (mm) Uzunluk (mm)	937	1250
Side panel (mm) Yan kapak (mm)	30	30

BUZ BR

Bread Display Cabinet / Ekmek Teşhir Reyonu



TAYFUN COOLING
Soğutma Sanayi Tic.Ltd.Sti



FIREFLY BR V1/75/130

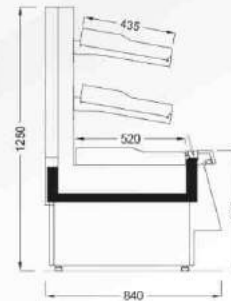

Technical Specifications Teknik Özellikler



Categories Kategoriler



Available Modules / Kullanılabilir Modüller				
Length (mm) Uzunluk (mm)	60	80	100	120
Side panel (mm) Yan kapak (mm)	30	30	30	30



TAYFUN COOLING
Soğutma Sanayi Tic.Ltd.Şti

COLD ROOMS

Soğuk Hava Depoları



Meat, milk, fruits and vegetables, bakery products, various frozen products, all kinds of food products like ice cream can be stored under the best Conditions and for the longest time possible in our cold storage rooms that are constituted with locked sandwich panels, which have been prepared with 42 kg/m³ density polyurethane. Our cold storage rooms, which could also be produced with glass doors, depending on your request could be used inside of the store for the purpose of both storing and for displaying.

- AISI 304, PVC coating or powder coated sheet metals can be used on internal and external surfaces of panels, depending on your request.
- Our panels can be produced in thicknesses of 80 mm, 100 mm, 120 mm, 160 mm and in 200 mm.
- In our cold storage rooms, which could also be set up with Atmospheric Control System depending on the requirements for large fruit and vegetable storage, fruits and vegetable can be stored under the most appropriate Conditions with the use of this system.
- While the corner panel, which can be manufactured as single piece, provides ease of assembly, it would also provide efficiency for the consumption of the energy at the same time as it provides much better insulation for your cold storage rooms.
- There are options of swing, sliding, monorail, sectional, flip-flap, fast passage and atmospheric controlled doors available depending on the requirements.

42 kg/m³ dansite poliüretanla hazırlanmış kilitleli sandviç panellerden oluşan soğuk hava depolarımızda et, süt, meyve-sebze, unlu gıdalar, çeşitli dondurulmuş ürünler ve dondurma gibi tüm gıda maddeleri en iyi şartlarda ve en uzun süreyle muhafaza edilebilirler. İsteğinize göre cam kapaklı olarak da üretilen soğuk hava depolarımız mağaza içinde hem muhafaza hem de teşhir amaçlı kullanılabilir.

- Panellerimizin iç ve dış yüzeylerinde isteğinize bağlı olarak AISI 304, PVC kaplama ya da elektrostatik toz boyalı saclar kullanılmaktadır.
- Panellerimiz; 80 mm, 100 mm, 120 mm, 160 mm ve 200 mm kalınlıklarında üretilmektedir.
- Büyük meyve ve sebze depoları için isteğe bağlı olarak Atmosfer Kontrollü Sistem ile de kurulabilen soğuk hava depolarımızda, bu sistem ile meyve ve sebzeler en uygun koşullarda muhafaza edilebilir.
- Tek parça üretilen köşe panelimiz montajda kolaylık imkânı verirken aynı zamanda soğuk hava depolarınızda daha kaliteli bir yalıtım sağlayarak enerji tüketiminizde verimlilik sağlar.
- İsteğinize bağlı olarak çarpma, sürgülü, monoray, seksiyonel, flip-flap, hızlı geçiş ve atmosfer kontrollü kapı seçenekleri mevcuttur.



Modular Cold Room / Modüler Soğuk Oda

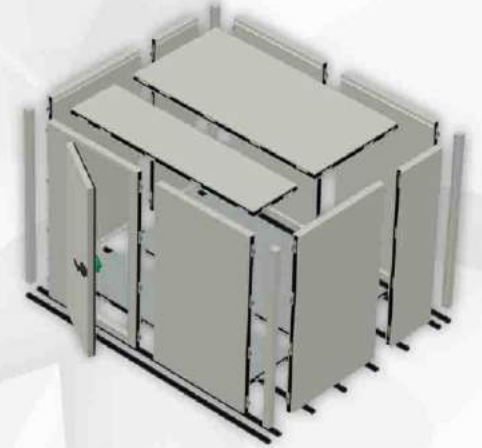

Modular Cold Room / Modüler Soğuk Oda



Cold Room Doors / Soğuk Oda Kapıları



TAYFUN COOLING
Soğutma Sanayi Tic.Ltd.Şti

COOLING SYSTEMS

Soğuk Hava Depoları



Double regime, Central Cooling System
Çift Rejimli Merkezi Soğutma Sistemi



Industrial Refrigeration System
Endüstriyel Soğutma Sistemi



Split Cooling System
Split Cooling System



Split Cooling System
Split Cooling System



Split Cooling System
Split Cooling System

UYGULAMA ŞEKİLLERİ

- Split Tip Soğutma Üniteleri
- Açık Tip Soğutma Grupları
- Mono Blok Soğutma Üniteleri
- Çift Rejimli Merkezi Soğutma Sistemleri
- Soğuk Su Üretme Üniteleri
- Tandem Soğutma Sistemleri

OPSIYONLAR

- İnvörtör Uygulaması
- Elektronik fan hız kontrol sistemi
- Bir merkezden izlenme ve kontrol edilebilme
- Co2 Soğutma Sistemi
- Eşanjör Uygulaması
- Isı geri kazanım uygulamaları

Application Types

- Split-Type Refrigeration Units
- Open Type Condensing Units
- Mono Block Refrigeration Units
- Twin Central Refrigeration Systems
- Chiller Units
- Tandem Cooling Systems

Options

- Inverter Application
- Electronic fan speed control system
- Control from one center by connecting to central automation systems
- Co2 Cooling System
- Heat Exchanger Application
- Heat recovery Applications

SPLIT TİP SOĞUTMA ÜRÜNLERİ

Tüm soğutma uygulamalarında kullanılabilecek ünitelerdir.

SPLIT TYPE REFRIGERATION UNITS

These units can be used in all cold-room applications.

Avantajları

- Cihaz gövdesi dış şartlara dayanıklı elektrostatik toz boyalı ve dekoratif görünümündür.
- İç ve dış ünite arasında bakır boru ve elektrik tesisatı çekilerek kısa sürede kolaylıkla monte edilebilmektedir.
- Tüm kontroller elektronik kontrol sistemleri ile yapılmaktadır.
- İstenilen değerlere kolayca programlanabilir.
- Tüm sistem koruma fonksiyonlarına sahiptir.
- Servisi kolaydır.

Advantages

- Body of the device is covered with electrostatic powder paint resistant to outer Conditions and has decorative appearance.
- Easy and fast installation, by connecting copper pipes and wiring between inner and outer units.
- All controls are conducted by means of electronic control systems
- Easy programming to requested values.
- Availability of all system protection functions.
- Easy service.

ÇİFT REJİMLİ MERKEZİ SOĞUTMA SİSTEMLERİ / TWIN CENTRAL REFRIGERATION SYSTEMS

Avantajları

- Kabinli modellerde cihaz gövdesi dış şartlara dayanıklı elektrostatik toz boyalı ve dekoratif görünümündür.
- Düşük yatırım maliyetleri.
- Yüksek soğutma performansı, geniş kapasite aralığı ve soğutmada süreklilik.
- % 30-35 enerji tasarrufu.
- Minimum yer işgali.
- Montaj, bakım ve servis kolaylığı.
- İstenilen değerlere kolayca programlanabilir.
- Bir merkezden izlenme ve kontrol edilebilme

SOĞUK SU ÜNİTELERİ

Klima tesisleri, plastik, ambalaj, kimya, ilaç, gıda ve bir çok sektörün proses suyu soğutma ihtiyaçları için tasarlanmış ünitelerdir. Su soğutma ünitelerinin soğuk su çıkış sıcaklığı isteğe bağlı olarak +2 °C ile +10 °C arasında değişik sıcaklıklar için imal edilmektedir. Sistem ihtiyaç ve kapasiteye bağlı olarak uygun kapasiteye sahip olacak şekilde tasarlanmakta ve 1 ila 4 arasında semihmetik kompresör kullanılmaktadır. Üniteler, soğutma grubuna ait bütün elemanların en uygun şekilde yerleştirilerek boyutları minimum olacak şekilde dizayn edilmektedir. Sistemdeki kompresör ve kondenser fanlarının çalışması kapasiteye bağlı olarak sensörlerden alınan bilgiler doğrultusunda bir mikroişlemci tarafından yapılmaktadır. İstenilmesi halinde kontrol paneline data hattı ile herhangi bir dış merkezden bağlanarak sistemin çalışması gözlenebilmekte ve basit müdahalelerde bulunabilmektedir. Elektrik besleme ve kumanda paneli ünite üzerinde olup tüm bağlantılar fabrikada yapılmaktadır.

Genel Ekipmanlar

Tüm tipler aşağıdaki elemanlara sahiptir.

- Semihmetik veya hermetik kompresörler.
- Yağ ayırıcı, yağ deposu, yağ basınç dengeleme valfi, alçak ve yüksek basınç kontrol otomatlığı.
- Tüm kompresörlerde emme basma hattı titreşim alıcıları, alçak yüksek basınç kontrol otomatikleri, yağ seviye düzenleyicileri.
- Soğutucu akışkan deposu.
- Likit ve dönüş hatlarında nem alıcı filtreler.
- Yatay tip likit akümülatörü.
- Çek valf ve küresel tip vanalar.

Advantages

- In models with a cabin, body of the device is covered with electrostatic powder paint resistant to outer Conditions and has decorative appearance.
- Low cost initial investment.
- High refrigeration performance, wide range of capacity and Permanency of refrigeration.
- 30-35 % energy saving.
- Minimum space occupation.
- Easy installation, maintenance and service.
- Easy programming to requested values.
- Control from one cente by connecting to central automation systems.

CHILLER UNITS

These are the units designed to meet process water-cooling needs of numerous sectors, such as air conditioning, plastics, packing, chemistry, pharmaceuticals, and food. Cold-water units can be manufactured with cold-water output temperature ranging from +2 °C to +10 °C, according to request. The system is designed with suitable capacity depending on need and load and made up of 1 to 4 semi-hermetic compressors. The elements of a cooling group are optimally located and designed to have the minimum sizes. Operation of compressor and condenser fans is carried out by a microprocessor according to data received from sensors depending on capacity. Upon request, the system operation can be observed and simple interference can be carried out from any remote center by means of connection to control panel through a data line. Power feeding and control panel are located on the unit and all connections are finished at the factory.

General Equipments

All types are supplied with the following equipment.

- Semi-hermetic or hermetic compressors.
- Oil separator, oil collector, oil pressure control valve, low and high pressure control automat, on the basis of one per a system.
- Discharge suction line vibration receivers, low and high pressure control automats, and oil level regulators in all compressors.
- Refrigeration liquid collector.
- Humidity receiver filters on liquid and return lines.
- Horizontal type liquid accumulator.
- Check valve and ball valves.

Heat Recovery System / Isı Geri Kazanım Sistemleri

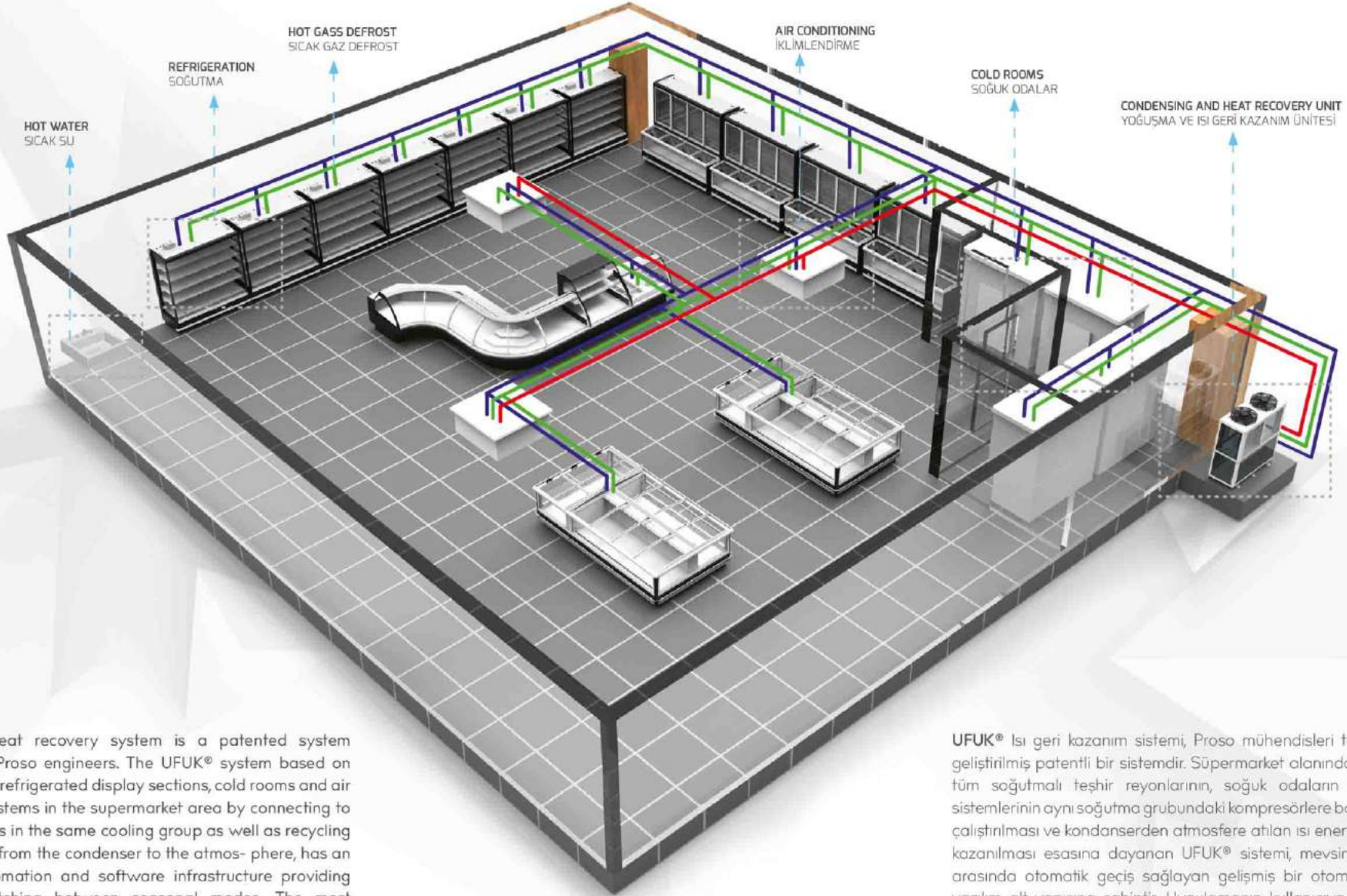

UFUK® The heat recovery system is a patented system developed by Proso engineers. The UFUK® system based on operation of all refrigerated display sections, cold rooms and air conditioning systems in the supermarket area by connecting to the compressors in the same cooling group as well as recycling of heat energy from the condenser to the atmosphere, has an advanced automation and software infrastructure providing automatic switching between seasonal modes. The most important benefit of the application to the user is Energy saving up to 65% . Feel the comfort of using the same external unit for both cooling and heating functions at the same time

UFUK® Isı geri kazanım sistemi, Proso mühendisleri tarafından geliştirilmiş patentli bir sistemdir. Süpermarket alanında bulunan tüm soğutmalı teşhir reyonlarının, soğuk odaların ve klima sistemlerinin aynı soğutma grubundaki kompresörlere bağlanarak çalıştırılması ve kondanserden atmosfere atılan ısı enerjisinin geri kazanılması esasına dayanan UFUK® sistemi, mevsim modları arasında otomatik geçiş sağlayan gelişmiş bir otomasyon ve yazılım alt yapısına sahiptir. Uygulamanın kullanıcıya sağladığı en önemli fayda, %65'e varan enerji tasarrufudur. Aynı dış üniteyi aynı anda hem soğutma hem de ısıtma fonksiyonları için kullanabilmenin rahatlığını hissedin.